

## Series MN

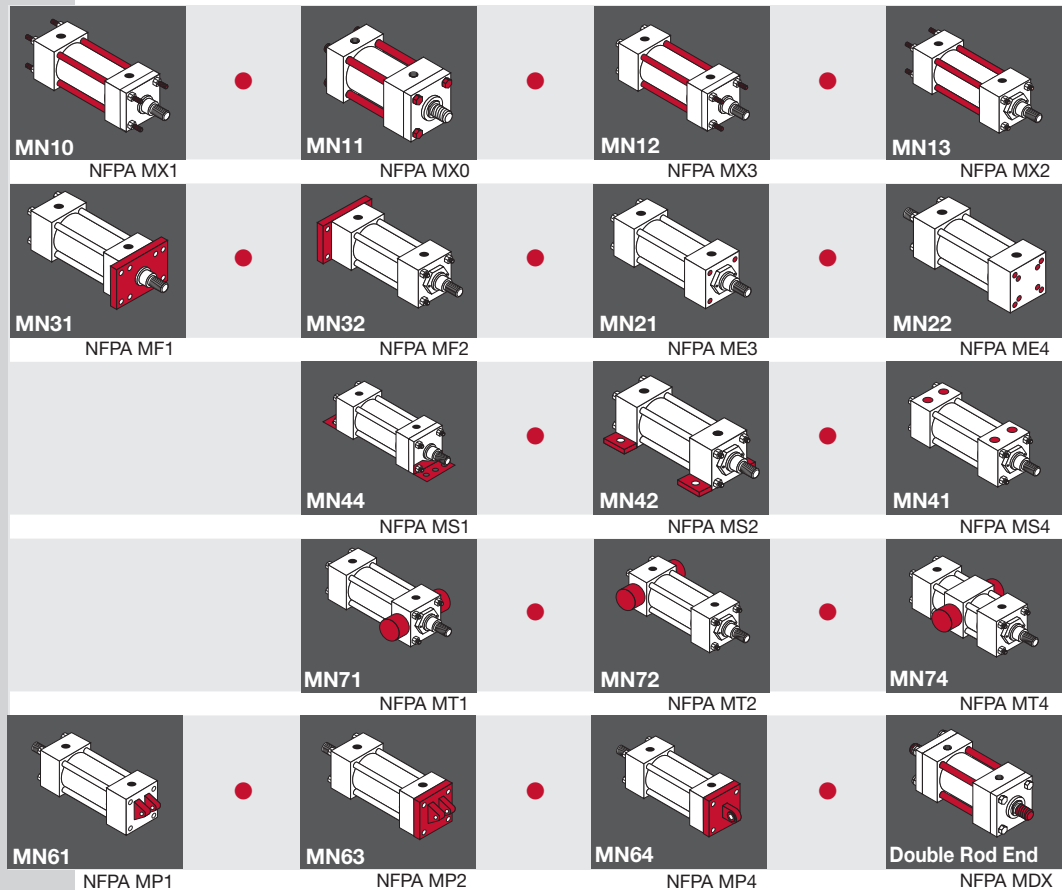

**Milwaukee Cylinder Series MN Aluminum Cylinders** are of heavy duty construction in ten bore sizes (1-1/2" up to 12"). Pneumatic operation up to 250 PSI is standard, and 400 PSI hydraulic non-shock operation is available. These high-alloy aluminum pneumatic cylinders are made to order, allowing you to meet the needs of your custom application. Series MN Cylinders are recognized for their durability and long-lasting performance.

<b>General</b>	<i>Standard Specifications and Features</i>	<b>104</b>
	<i>Series MN Piston Rod End Styles &amp; Base Cylinder Dimensions</i>	<b>105</b>
<b>Mounting Specifications</b>	<i>Tie-Rod Mount</i>	<b>106</b>
	<i>Flange Mount</i>	<b>107</b>
	<i>Side Mount and Lug Mount</i>	<b>108-109</b>
	<i>Trunnion Mount</i>	<b>110</b>
	<i>Clevis and Eye Mount</i>	<b>111</b>
	<i>Double Rod End Cylinders</i>	<b>112</b>
<b>Basic Options</b>	<i>Basic Option Index</i>	<b>113</b>
	<i>Basic Options</i>	<b>114-123</b>
<b>Accessories</b>	<i>Clevis, Pins and Mounts</i>	<b>124-125</b>
	<i>Stainless Steel Clevis, Pins and Mounts</i>	<b>126</b>
	<i>Switches</i>	<b>127-129</b>
	<i>Switches and Brackets</i>	<b>130</b>
	<i>Switch Mounting</i>	<b>131</b>
	<i>Switches Hysterises and Band Width</i>	<b>132</b>
<b>Additional Information</b>	<i>Switch Ordering Instructions</i>	<b>133</b>
	<i>Series MN Ordering Information</i>	<b>134</b>

Max. Operating Pressure:

## 250 psi

Operating Temperature, **Buna-N:**

## -20° F to 200° F

Operating Temperature, **Viton:**

## -15° F to 350° F

### FLOATING ROD BUSHING

#### Self Alignment Feature

Rod Bushing is designed to float .002", improving bearing surface alignment.

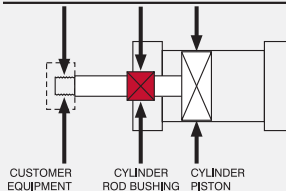

- Reduces cylinder drag and erratic operation
- Reduces cylinder wear
- Provides a minimum of 25% longer life than "fixed" Rod Bushing designs

Piston Wear Band

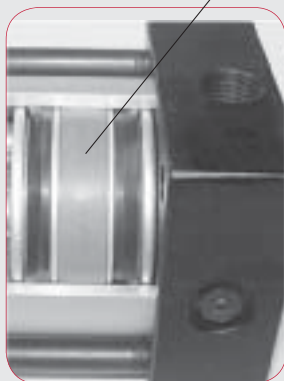

**MilCad Cylinder Configurator**

Visit [milwaukee-cylinder.com](http://milwaukee-cylinder.com) to configure and download CAD files of your cylinders.

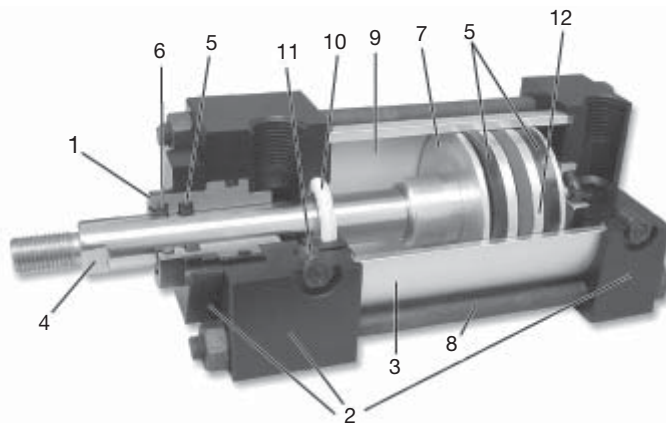

### STANDARD FEATURES

1. **Floating Rod Bushing**  
Precision machined from 150,000 psi rated graphite filled cast iron and PTFE coated to reduce friction and extend cycle life. Bushing design "traps" lubrication in effective bearing area.
2. **Head, Cap & Retainer**  
Precision machined from high strength 6061-T6 aluminum alloy. Black anodized for corrosion resistance.
3. **Cylinder Tube**  
Precision machined from 6063-T6832 high tensile aluminum alloy and hard coat to 60 Rc for wear resistance and extended cycle life.
4. **Piston Rod**  
Precision machined from high yield, polished and hard chrome plated steel.
5. **Piston & Rod Seals**  
Heavy lip design Buna-N Nitrile construction. Seals are pressure activated and wear compensating with PTFE piston wear band for long life. (Self lubricating material).
6. **Rod Wiper**  
Abrasion resistant urethane provides aggressive wiping action in all environments. External lip design prevents debris from entering cylinder.
7. **Piston**  
Precision machined from 6061-T651 alloy aluminum, provides an excellent bearing surface for extended cylinder life.
8. **Tie Rods**  
Prestressed high carbon steel tie rod construction eliminates axial loading of cylinder tube and maintains compression on tube and end seals.
9. **Permanent Lubrication**  
Permanently lubricated with PTFE based grease on all internal components. This is a non-migratory type high performance grease providing outstanding service life. No additional lubrication is required.
10. **Cushions**  
(Options H & C) Floating cushion seal designed for maximum cushion performance, quick return stroke break-away and extended life.
11. **Cushion Adjustment Needle**  
Adjustable steel needle design has fine thread metering and is positively captured to prevent needle ejection during adjustment.
12. **Piston Magnet**  
(Option MPR/MPH - see page 120) for Milwaukee Cylinder magnetically operated Reed and Solid State switches (refer to pages 127-133).

### PERFORMANCE OPTIONS

**ST** – Stop Tubes are used to reduce rod bearing and piston stress (refer to page 108 for cylinder design guidance).

**MA** – Micro-Adjust provides a precision adjustment on the cylinder extend stroke, providing quick and accurate cylinder positioning, reducing set-up time.

**SSA** – Stainless Steel Piston Rod, Tie Rods, Nuts, and Fasteners provide corrosion resistance in outdoor applications and wet environments.

**LF** – Low Friction Seals reduce breakaway and running friction. Effective at all operating pressures.

**NR** – Non-Rotating option incorporates (2) internal guide rods preventing rod rotation (NFPA dimensions).

## ABOUT ROD END STYLES

Style KK1 Male Rod End is STANDARD. (If no rod style is specified, it will be supplied with KK1). Other NFPA Styles can be specified (See Chart).

Need a rod end not listed? NO PROBLEM! Each Piston Rod is made to order and does not delay shipment. Coarse (UNC) threads, metric threads or just plain rod ends are common. Thread lengths are also made to order (Specify: "A"= Length).

NEED SOMETHING NOT LISTED? Contact the factory to discuss your custom requirements.

BORE	ROD MM	STANDARD		OPTIONAL		OPTIONAL		OPTIONAL		OPTIONAL		C	V
		KK1	A	KK2	A	KK3	A	KK4	A	KK5			
1½, 2, 2½	5/8	7/16-20	3/4	1/2-20	3/4	7/16-20	3/4	5/8-18	3/4	No Threads	3/8	1/4	
	1	3/4-16	1 1/8	7/8-14	1 1/8	3/4-16	1 1/8	1-14	1 1/8	No Threads	1/2	1/2	
3¼, 4, 5	1	3/4-16	1 1/8	7/8-14	1 1/8	3/4-16	1 1/8	1-14	1 1/8	No Threads	1/2	1/4	
	1 3/8	1-14	1 5/8	1 1/4-12	1 5/8	1-14	1 5/8	1 3/8-12	1 5/8	No Threads	5/8	3/8	
6 & 8	1 3/8	1-14	1 5/8	1 1/4-12	1 5/8	1-14	1 5/8	1 3/8-12	1 5/8	No Threads	5/8	3/8	
	1 3/4	1 1/4-12	2	1 1/2-12	2	1 1/4-12	2	1 3/4-12	2	No Threads	3/4	1/2	
10	1 3/4	1 1/4-12	2	1 1/2-12	2	1 1/4-12	2	1 3/4-12	2	No Threads	3/4	1/2	
	2	1 1/2-12	2 1/4	1 3/4-12	2 1/4	1 1/2-12	2 1/4	2-12	2 1/4	No Threads	7/8	3/8	
12	2	1 1/2-12	2 1/4	1 3/4-12	2 1/4	1 1/2-12	2 1/4	2-12	2 1/4	No Threads	7/8	3/8	
	2 1/2	1 7/8-12	3	2 1/4-12	3	1 7/8-12	3	2 1/2-12	3	No Threads	1	1/2	

## BASIC CYLINDER

MODEL MN11  
NFPA STYLE MX0 (No mount)

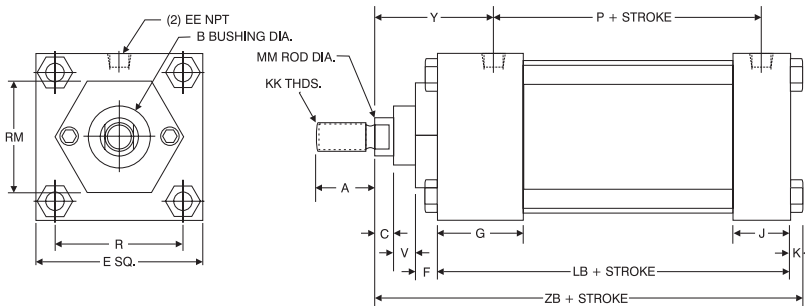

Bore Ø	Rod MM	Cylinder Code	A	B	C	E	EE	F	G	J	K	KK	LB	P	R	RM	V	Y	ZB
1½	5/8	MN00611	3/4	1 1/8	3/8	2	3/8	3/8	1 1/2	1	1/4	7/16-20	3 5/8	2 3/8	1.43	2 Sq.	1/4	1 7/8	4 7/8
	1	MN00612	1 1/8	1 1/2	1/2	2	3/8	3/8	1 1/2	1	1/4	3/4-16	3 5/8	2 3/8	1.43	2 Sq.	1/2	2 1/4	5 1/4
2	5/8	MN06110	3/4	1 1/8	3/8	2 1/2	3/8	3/8	1 1/2	1	5/16	7/16-20	3 5/8	2 3/8	1.84	1 1/4 Hex	1/4	1 7/8	4 15/16
	1	MN06111	1 1/8	1 1/2	1/2	2 1/2	3/8	3/8	1 1/2	1	5/16	3/4-16	3 5/8	2 3/8	1.84	2 1/2 Sq.	1/2	2 1/4	5 5/16
2½	5/8	MN06120	3/4	1 1/8	3/8	3	3/8	3/8	1 1/2	1	5/16	7/16-20	3 3/4	2 1/2	2.19	1 1/4 Hex	1/4	1 7/8	5 1/16
	1	MN06121	1 1/8	1 1/2	1/2	3	3/8	3/8	1 1/2	1	5/16	3/4-16	3 3/4	2 1/2	2.19	3 Sq.	1/2	2 1/4	5 7/16
3¼	1	MN06130	1 1/8	1 1/2	1/2	3 3/4	1/2	5/8	1 3/4	1 1/4	3/8	3/4-16	4 1/4	2 3/4	2.76	2 3/4 Dia.	1/4	2 3/8	6
	1 3/8	MN06131	1 5/8	2	5/8	3 3/4	1/2	5/8	1 3/4	1 1/4	3/8	1-14	4 1/4	2 3/4	2.76	3 3/4 Sq.	3/8	2 5/8	6 1/4
4	1	MN06140	1 1/8	1 1/2	1/2	4 1/2	1/2	5/8	1 3/4	1 1/4	3/8	3/4-16	4 1/4	2 3/4	3.32	2 3/4 Dia.	1/4	2 3/8	6
	1 3/8	MN06141	1 5/8	2	5/8	4 1/2	1/2	5/8	1 3/4	1 1/4	3/8	1-14	4 1/4	2 3/4	3.32	3 1/2 Dia.	3/8	2 5/8	6 1/4
5	1	MN06150	1 1/8	1 1/2	1/2	5 1/2	1/2	5/8	1 3/4	1 1/4	7/16	3/4-16	4 1/2	3	4.10	2 3/4 Dia.	1/4	2 3/8	6 5/16
	1 3/8	MN06151	1 5/8	2	5/8	5 1/2	1/2	5/8	1 3/4	1 1/4	7/16	1-14	4 1/2	3	4.10	3 1/2 Dia.	3/8	2 5/8	6 9/16
6	1 3/8	MN06160	1 5/8	2	5/8	6 1/2	3/4	5/8	2	1 1/2	7/16	1-14	5	3 1/4	4.88	3 1/2 Dia.	3/8	2 3/4	7 1/16
	1 3/4	MN06161	2	2 3/8	3/4	6 1/2	3/4	5/8	2	1 1/2	7/16	1 1/4-12	5	3 1/4	4.88	3 1/2 Dia.	1/2	3	7 5/16
8	1 3/8	MN06180	1 5/8	2	5/8	8 1/2	3/4	5/8	2	1 1/2	9/16	1-14	5 1/8	3 3/8	6.44	3 1/2 Dia.	3/8	2 3/4	7 5/16
	1 3/4	MN06181	2	2 3/8	3/4	8 1/2	3/4	5/8	2	1 1/2	9/16	1 1/4-12	5 1/8	3 3/8	6.44	3 1/2 Dia.	1/2	3	7 9/16
10	1 3/4	MN61100	2	2 3/8	3/4	10 5/8	1	5/8	2 1/4	2	1 1/16	1 1/4-12	6 3/8	4 5/16	7.92	3 1/2 Dia.	1/2	3 1/16	8 15/16
	2	MN61101	2 1/4	2 5/8	7/8	10 5/8	1	3/4	2 1/4	2	1 1/16	1 1/2-12	6 3/8	4 5/16	7.92	5 Dia.	3/8	3 3/16	9 1/16
12	2	MN61200	2 1/4	2 5/8	7/8	12 3/4	1	3/4	2 1/4	2	1 1/16	1 1/2-12	6 7/8	4 13/16	9.40	5 Dia.	3/8	3 3/16	9 9/16
	2 1/2	MN61201	3	3 3/8	1	12 3/4	1	3/4	2 1/4	2	1 1/16	1 7/8-12	6 7/8	4 13/16	9.40	5 Dia.	1/2	3 7/16	9 13/16

### TIE ROD MOUNTED CYLINDERS

Tie-rod mounts are suited for many applications and are similar to flange mounts, but tie-rod mounts are not as rigid as the flange type of mounting. The best use of tie-rods extended on the blind end is in a thrust load application. When using tie-rod extended on the rod end, the best application is a tension load. When long strokes are required, the free end should be supported to prevent misalignment, sagging or possible binding of the cylinder.

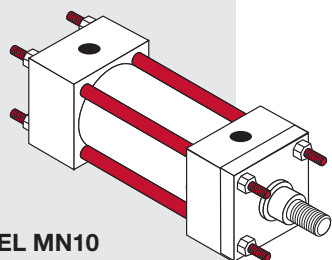

**MODEL MN10**  
NFPA STYLE MX1

#### TIE RODS EXTENDED BOTH END

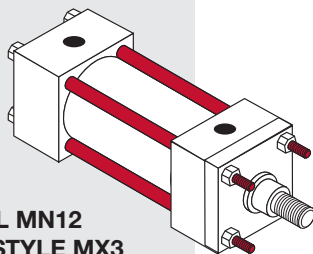
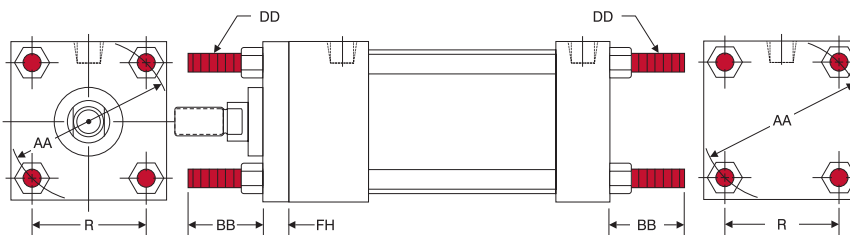

**MODEL MN12**  
NFPA STYLE MX3

#### TIE RODS EXTENDED ROD END

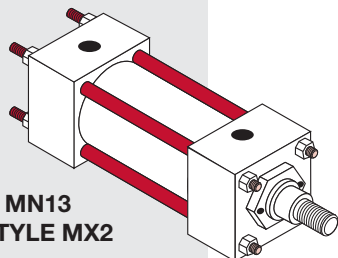
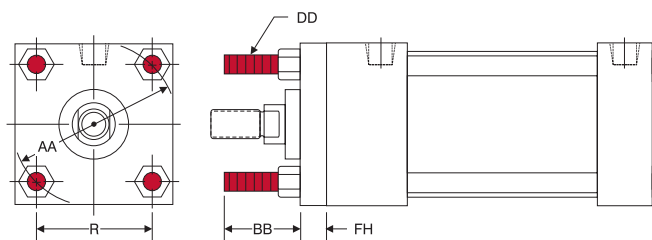

**MODEL MN13**  
NFPA STYLE MX2

#### TIE RODS EXTENDED BLIND END

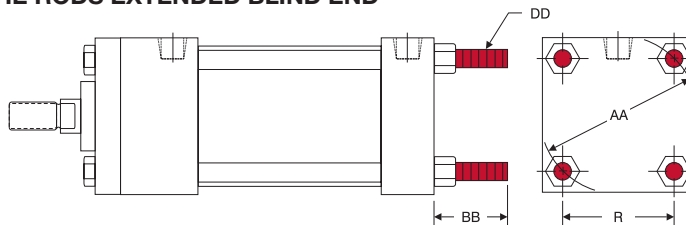

#### HOW TO ORDER

For ordering information refer to Page 134.

#### NOTES:

- For double rod end cylinders, add prefix letter D to cylinder code. Example: DMN00611. (Refer to page 112.)

**Rod End Styles and Dimensions**  
For rod end styles and dimensions see:  
Page 105

**MilCad Cylinder Configurator**  
Visit [milwaukee-cylinder.com](http://milwaukee-cylinder.com) to configure and download CAD files of your cylinders.

TIE ROD EXTENDED 'MN10', 'MN12', 'MN13' MOUNT DIMENSIONS							
Bore Ø	Rod MM	Cylinder Code ↓	AA	BB	DD	FH	R
1½	5/8	MN00611	2.02	1	¼-28	3/8	1.43
	1	MN00612					
2	5/8	MN06110	2.6	1½	5/16-24	3/8	1.84
	1	MN06111					
2½	5/8	MN06120	3.1	1½	5/16-24	3/8	2.19
	1	MN06121					
3¼	1	MN06130	3.9	1¾	¾-24	5/8	2.76
	1¾	MN06131					
4	1	MN06140	4.7	1¾	¾-24	5/8	3.32
	1¾	MN06141					
5	1	MN06150	5.8	1¾ <sup>16</sup>	½-20	5/8	4.10
	1¾	MN06151					
6	1¾	MN06160	6.9	1¾ <sup>16</sup>	½-20	¾	4.88
	1¾	MN06161					
8	1¾	MN06180	9.1	**2 <sup>5</sup> / <sub>16</sub>	5/8-18	*5/8	6.44
	1¾	MN06181					
10	1¾	MN61100	11.2	**2 <sup>11</sup> / <sub>16</sub>	¾-16	*5/8	7.92
	2	MN61101				*¾	
12	2	MN61200	13.3	**2 <sup>11</sup> / <sub>16</sub>	¾-16	*¾	9.40
	2½	MN61201					

\* MX1 and MX3 have full square bushing retainer on 1½" - 6" bores, round retainers on 8"-12" bores.  
\*\* BB dimensions from face of head. For dimensions not shown, see page 105.

### ROD RECTANGULAR FLANGE MOUNTING (1½" - 6" bore only)

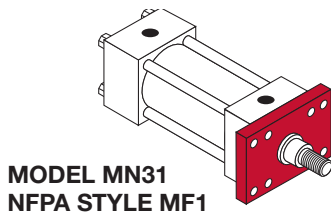

**MODEL MN31  
NFFPA STYLE MF1**

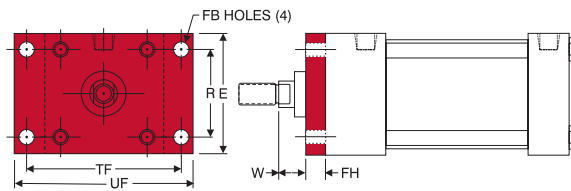

### BLIND RECTANGULAR FLANGE MOUNTING (1½" - 6" bore only)

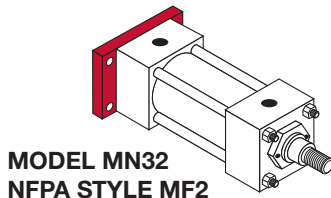

**MODEL MN32  
NFFPA STYLE MF2**

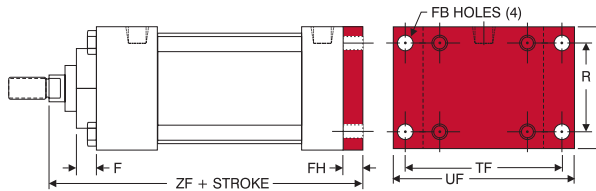

### ROD SQUARE FLANGE MOUNTING (8" - 12" bore only)

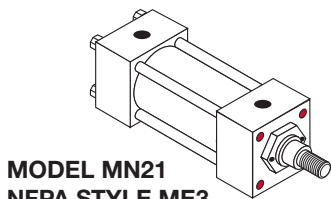

**MODEL MN21  
NFFPA STYLE ME3**

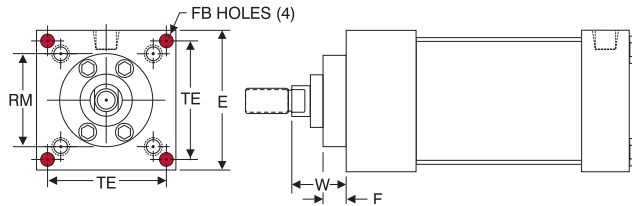

### BLIND SQUARE FLANGE MOUNTING (8" - 12" bore only)

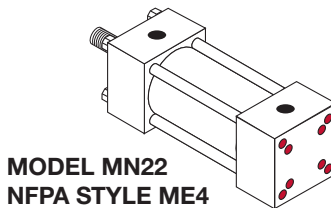

**MODEL MN22  
NFFPA STYLE ME4**

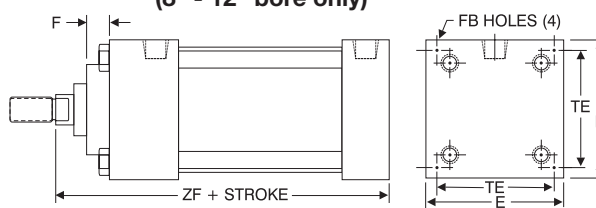

**'MN31', 'MN32' FLANGE MOUNT & 'MN21', 'MN22' CAP MOUNT DIMENSIONS**

Bore Ø	Rod MM	Cylinder Code ↓	E	F	FB	FH	R	RM	TE	TF	UF	W	ZF
1½	5/8**	MN00611	2	3/8	5/16	3/8	1.43	—	—	2¾	3¾	5/8	5
	1**	MN00612										1	5¾
2	5/8**	MN06110	2½	3/8	3/8	3/8	1.84	—	—	3¾	4½	5/8	5
	1**	MN06111										1	5¾
2½	5/8**	MN06120	3	3/8	3/8	3/8	2.19	—	—	3¾	4¾	5/8	5½
	1**	MN06121										1	5½
¾	1**	MN06130	3¾	5/8	7/16	5/8	2.76	—	—	4¼	5½	¾	6¼
	1¾**	MN06131										1	6½
4	1**	MN06140	4½	5/8	7/16	5/8	3.32	—	—	5¾	6¼	¾	6¼
	1¾**	MN06141										1	6½
5	1**	MN06150	5½	5/8	9/16	5/8	4.10	—	—	6¾	7¾	¾	6½
	1¾**	MN06151										1	6¾
6	1¾**	MN06160	6½	5/8	9/16	¾	4.88	—	—	7¾	8¾	7/8	7¾
	1¾**	MN06161										1	7¾
8	1¾*	MN06180	8½	5/8	11/16	N/A	N/A	3½	7.57	N/A	N/A	1¾	6¾
	1¾*	MN06181										1¾	7
10	1¾*	MN61100	10¾	5/8	13/16	N/A	N/A	3½	9.40	N/A	N/A	1¾	8¼
	2*	MN61101										2	8¾
12	2*	MN61200	12¾	¾	13/16	N/A	N/A	5	11.1	N/A	N/A	2	8¾
	2½*	MN61201										2¼	9½

For dimensions not shown, see page 105.

### FLANGE MOUNTED CYLINDERS

The flange mount is one of the strongest, most rigid methods of mounting. With this type of mount there is little allowance for misalignment, though when long strokes are required, the free end opposite the mounting should be supported to prevent sagging and possible binding of the cylinder. The best use of a blind end flange is in a thrust load application (rod in compression).

Rod end flange mounts are best used in tension applications.

When a less rigid mount can be used and the cylinder can be attached to a panel or bulkhead, an extended tie-rod mounting could be considered.

### HOW TO ORDER

For ordering information refer to Page 134.

### NOTES:

◆ For double rod end cylinders, add prefix letter D to cylinder code. Example: DMN00611. (Refer to page 112.)

\* Models MN31 and MN32 not available in these sizes.

\*\* Models MN21 and MN22 not available in these sizes.

**Rod End Styles and Dimensions**  
For rod end styles and dimensions see:

## HOW TO ORDER

For ordering information refer to Page 134.

### NOTES:

- ◆ For double rod end cylinders, add prefix letter D to cylinder code. Example: DMN00611. (Refer to page 112.)

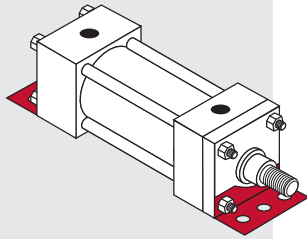

**MODEL MN44  
NFA STYLE MS1**

## SIDE OR LUG MOUNTED CYLINDERS

The side or lug mounted cylinder provides a fairly rigid mount. These types of cylinders can tolerate a slight amount of misalignment when the cylinder is at full stroke, but as the piston moves toward the blind end, the tolerance for misalignment decreases. It is important to note that if the cylinder is used properly (without misalignment), the mounting bolts are either in simple shear or tension without any compound stresses.

### ANGLE MOUNTING

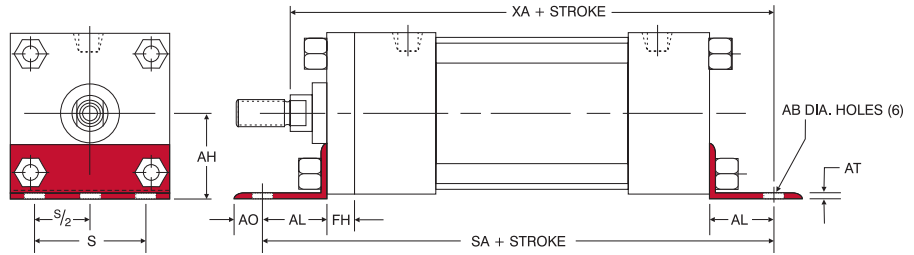

'MN44' ANGLE MOUNT DIMENSIONS

Bore Ø	Rod MM	Cylinder Code ◆	AB	AH	AL	AO	AT	FH	S	Add Stroke	
										SA▲	XA
1½	5/8	MN00611	7/16	13/16	1	3/8	1/8	3/8	1¼	6	55/8
	1	MN00612									6
2	5/8	MN06110	7/16	17/16	1	3/8	1/8	3/8	1¾	6	55/8
	1	MN06111									6
2½	5/8	MN06120	7/16	15/8	1	3/8	1/8	3/8	2¼	6½	5¾
	1	MN06121									6½
3¼	1	MN06130	9/16	115/16	1¼	½	1/8	5/8	2¾	73/8	67/8
	13/8	MN06131									71/8
4	1	MN06140	9/16	2¼	1¼	½	1/8	5/8	3½	73/8	67/8
	13/8	MN06141									71/8
5	1	MN06150	11/16	2¾	13/8	5/8	3/16	5/8	4¼	77/8	7¼
	13/8	MN06151									7½
6	13/8	MN06160	13/16	3¼	13/8	5/8	3/16	¾	5¼	8½	8
	1¾	MN06161									8¼
8	13/8	MN06180	13/16	4¼	113/16	11/16	¼	5/8*	71/8	8¾	89/16
	1¾	MN06181									813/16

\*3½" diameter round retainer on 8" bore. (MA1 bracket bolted directly to head)  
For dimensions not shown, see page 105.

▲ For Double Rod End, add 1/2" + FH to this dimension.



### Rod End Styles and Dimensions

For rod end styles and dimensions see:

Page 105



### MilCad Cylinder Configurator

Visit [milwaukeekeecylinder.com](http://milwaukeekeecylinder.com) to configure and download CAD files of your cylinders.

## SIDE LUG MOUNTING

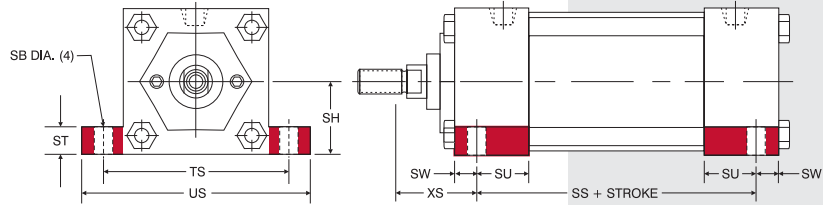
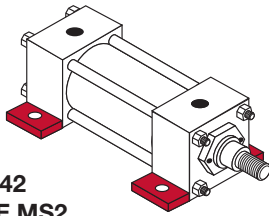

**MODEL MN42  
NFFA STYLE MS2**

'MN42' SIDE LUG MOUNT DIMENSIONS												
Bore Ø	Rod MM	Cylinder Code ♦	SB	SH	ST	SU	SW	SZ	TS	US	XS	Add Stroke SS*
1½	5/8	MN00611	7/16	1	½	1 1/8	3/8	5/8	2 3/4	3 1/2	1 3/8	2 7/8
	1	MN00612									1 1/4	
2	5/8	MN06110	7/16	1 1/4	½	1 1/8	3/8	5/8	3 1/4	4	1 3/8	2 7/8
	1	MN06111									1 3/4	
2½	5/8	MN06120	7/16	1 1/2	½	1 1/8	3/8	5/8	3 3/4	4 1/2	1 3/8	3
	1	MN06121									1 3/4	
3¼	1	MN06130	9/16	1 7/8	¾	1 1/4	½	¾	4 3/4	5 3/4	1 7/8	3 1/4
	1 3/8	MN06131									2 1/8	
4	1	MN06140	9/16	2 1/4	¾	1 1/4	½	¾	5 1/2	6 1/2	1 7/8	3 1/4
	1 3/8	MN06141									2 1/8	
5	1	MN06150	1 3/16	2 3/4	1	1 1/16	1 1/16	9/16	6 7/8	8 1/4	2 1/16	3 1/8
	1 3/8	MN06151									2 5/16	
6	1 3/8	MN06160	1 3/16	3 1/4	1	1 5/16	1 1/16	1 3/16	7 7/8	9 1/4	2 5/16	3 5/8
	1 3/4	MN06161									2 9/16	
8	1 3/8	MN06180	1 3/16	4 1/4	1	1 5/16	1 1/16	1 3/16	9 7/8	11 1/4	2 5/16	3 3/4
	1 3/4	MN06181									2 9/16	

For dimensions not shown, see page 105.

### HOW TO ORDER

For ordering information refer to Page 134.

### NOTES:

♦ For double rod end cylinders, add prefix letter D to cylinder code. Example: DMN00611. (Refer to page 112.) Double rod ends are not available on clevis mount Series MN cylinders.

\* For Double Rod End Cylinders add 1/2" to this dimension.

## TAPPED HOLES IN CAPS FLUSH MOUNTING

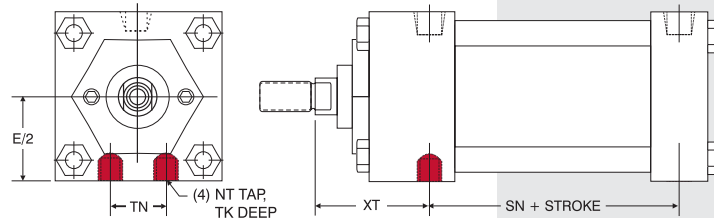
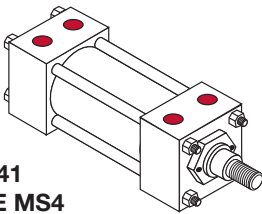

**MODEL MN41  
NFFA STYLE MS4**

'MN41' TAPPED HOLE MOUNT DIMENSIONS								
Bore Ø	Rod MM	Cylinder Code ♦	E/2	NT	TK	TN	XT	Add Stroke SN
1½	5/8	MN00611	1	¼-20	3/8	5/8	1 15/16	2 1/4
	1	MN00612					2 5/16	
2	5/8	MN06110	1 1/4	5/16-18	½	7/8	1 15/16	2 1/4
	1	MN06111					2 5/16	
2½	5/8	MN06120	1 1/2	3/8-16	5/8	1 1/4	1 15/16	2 3/8
	1	MN06121					2 5/16	
3¼	1	MN06130	1 7/8	½-13	¾	1 1/2	2 7/16	2 5/8
	1 3/8	MN06131					2 11/16	
4	1	MN06140	2 1/4	½-13	¾	2 1/16	2 7/16	2 5/8
	1 3/8	MN06141					2 11/16	
5	1	MN06150	2 3/4	5/8-11	1	2 11/16	2 7/16	2 7/8
	1 3/8	MN06151					2 11/16	
6	1 3/8	MN06160	3 1/4	¾-10	1 1/8	3 1/4	2 13/16	3 1/8
	1 3/4	MN06161					3 1/16	
8	1 3/8	MN06180	4 1/4	¾-10	1 1/8	4 1/2	2 13/16	3 1/4
	1 3/4	MN06181					3 1/16	
10	1 3/4	MN61100	5 5/16	1-8	1 1/2	5 1/2	3 1/8	4 1/8
	2	MN61101					3 1/4	
12	2	MN61200	6 3/8	1-8	1 1/2	7 1/4	3 1/4	4 5/8
	2 1/2	MN61201					3 1/2	

For dimensions not shown, see page 105.

**Rod End Styles and Dimensions**  
For rod end styles and dimensions see:  
Page 105

**MilCad Cylinder Configurator**  
Visit [milwaukeeecylinder.com](http://milwaukeeecylinder.com) to configure and download CAD files of your cylinders.



Series H

Series MH

Series LH

Series A

Series MN

**NOTE:**

MT1 and MT2 trunnions are bolt on, non-removable design.

**TRUNNION CYLINDERS**

All trunnion cylinders need a provision on both ends for pivoting. These types of cylinders are designed to carry shear loads and the trunnion pins should be carried by bearings that are rigidly held and closely fit for the entire length of the pin.

**MODEL MN71  
NFPA STYLE MT1**

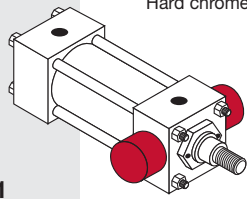

**ROD END TRUNNION MOUNT**

Hard chrome plated O.D. wear surface on trunnions

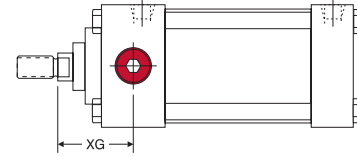
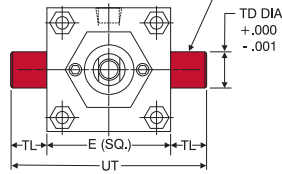

**MODEL MN72  
NFPA STYLE MT2**

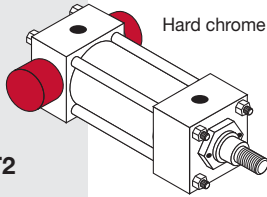

**BLIND END TRUNNION MOUNT**

Hard chrome plated O.D. wear surface on trunnions

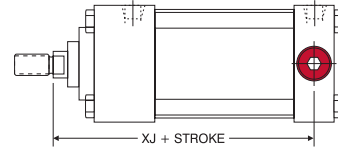
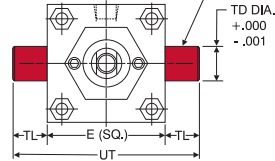

'MN71' AND 'MN72' TRUNNION MOUNT DIMENSIONS									ACCESSORIES (see pages 110-111 for dimensions)		
Bore Ø	Rod MM	Cylinder Code ♦	E	TD	TL	UT	XG	Add Stroke XJ	Rod Clevis	Rod Eye	Clevis Pin
1½*	5/8	MN00611	2	1	1	4	1¼	4½	RC437	RE437	CP500
	1	MN00612					N/A*	4½	RC750	RE750	CP750
2	5/8	MN06110	2½	1	1	4½	1¼	4½	RC437	RE437	CP500
	1	MN06111					2½	4½	RC750	RE750	CP750
2½	5/8	MN06120	3	1	1	5	1¼	4¼	RC437	RE437	CP500
	1	MN06121					2½	4½	RC750	RE750	CP750
¾	1	MN06130	¾	1	1	5¼	2¼	5	RC750	RE750	CP750
	1¾	MN06131					2½	5¼	RC1000	RE1000	CP1000
4	1	MN06140	4½	1	1	6½	2¼	5	RC750	RE750	CP750
	1¾	MN06141					2½	5¼	RC1000	RE1000	CP1000
5	1	MN06150	5½	1	1	7½	2¼	5¼	RC750	RE750	CP750
	1¾	MN06151					2½	5½	RC1000	RE1000	CP1000
6	1¾	MN06160	6½	1¾	1¾	9¼	2⅝	5⅞	RC1000	RE1000	CP1000
	¾	MN06161					2⅞	6⅞	RC1250	RE1250	CP1375
8	1¾	MN06180	8½	1¾	1¾	11¼	2⅝	6	RC1000	RE1000	CP1000
	¾	MN06181					2⅞	6¼	RC12505	RE1250	CP1375

\*No oversize rod available on 1½" bore MT1. For dimensions not shown, see page 105.

NOTE: MT4 Trunnions and Intermediate section are one-piece steel construction.

**MODEL MN74  
NFPA STYLE MT4**

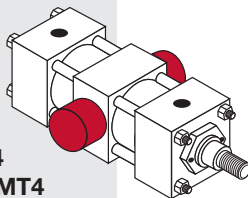

**CENTER TRUNNION MOUNT**

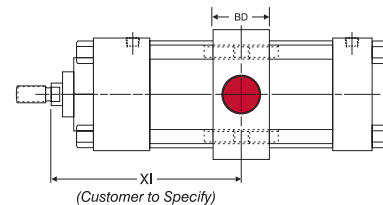
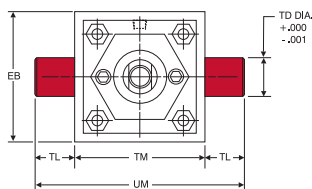

**HOW TO ORDER**

For ordering information refer to Page 134.

**NOTES:**

- ♦ For double rod end cylinders, add prefix letter D to cylinder code. Example: DMN00611. (Refer to page 112.)

'MN74' CENTER TRUNNION MOUNT DIMENSIONS							
Bore Ø	BD	EB	TD	TL	TM	UM	X1
1½	1¼	2½	1	1	2½	4½	CUSTOMER TO SPECIFY
2	1½	3	1	1	3	5	
2½	1½	3½	1	1	3½	5½	
¾	2	4¼	1	1	4½	6½	
4	2	5	1	1	5¼	7¼	
5	2	6	1	1	6¼	8¼	
6	2	7	1¾	1¾	7⅞	10⅞	
8	2½	9½	1¾	1¾	9¾	12½	

## CLEVIS MOUNT

**Extruded MP1 Mount**  
(Extruded: 1½" - 8" Bores, Weldment: 10" & 12" Bores)

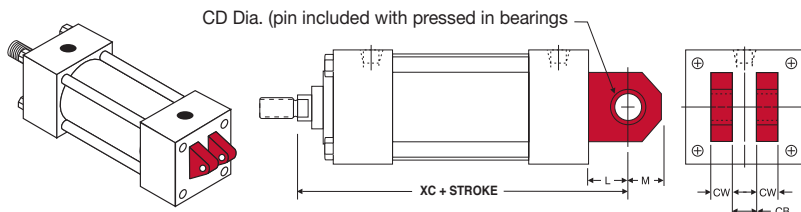

**Iron Casting MP1 Mount**  
(Optional)\*\*

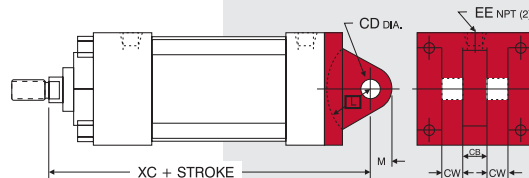

**MODEL MN61**  
NFFA STYLE MP1

## REMOVABLE CLEVIS MOUNT

**MP2 Mount**  
(Iron Casting)

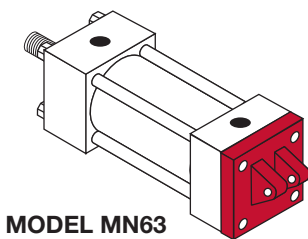

**MODEL MN63**  
NFFA STYLE MP2

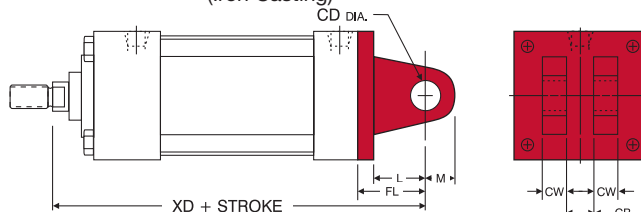

### HOW TO ORDER

For ordering information refer to Page 134.

### NOTES:

- ◆ For double rod end cylinders, add prefix letter D to cylinder code. Example: DMN00611. (Refer to page 112.)

### Rod End Styles and Dimensions

For rod end styles and dimensions see:

Page 105

### MilCad Cylinder Configurator

Visit [milwaukeecylinder.com](http://milwaukeecylinder.com) to configure and download CAD files of your cylinders.

See pages 124-125 for dimensions.

## REMOVABLE FIXED EYE MOUNT

**MP4 Mount**

(Iron Casting: 1½" - 4" Bores, Weldment: 5" & 6" Bores)

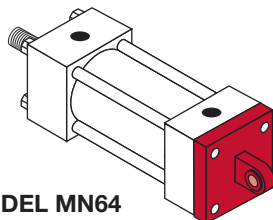

**MODEL MN64**  
NFFA STYLE MP4

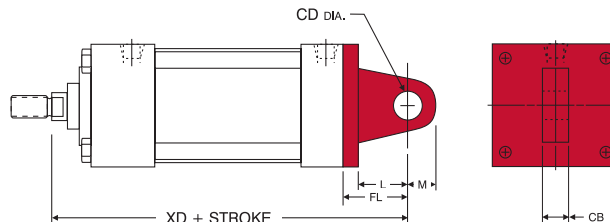

'MN61', 'MN63' CLEVIS AND 'MN64' EYE MOUNT DIMENSIONS (in)										ACCESSORIES (see pages 110-111 for dimensions)					
Bore Ø	Rod MM	Cylinder Code ◆	CB	CD	CW	FL	L	M	XC	XD	Rod Clevis	Rod Eye	Clevis Pin	Eye Bracket (for MP1)	Clevis Bracket (for MP4)
1½	5/8	MN00611	3/4	1/2	1/2	1 1/8	3/4	5/8	5 3/8	5 3/4	RC437	RE437	CP500		
	1	MN00612							5 3/4	6 1/8	RC750	RE750	CP750		
2	5/8	MN06110	3/4	1/2	1/2	1 1/8	3/4	5/8	5 3/8	5 3/4	RC437	RE437	CP500	EB500	CB500
	1	MN06111							5 3/4	6 1/8	RC750	RE750	CP750		
2½	5/8	MN06120	3/4	1/2	1/2	1 1/8	3/4	5/8	5 1/2	5 7/8	RC437	RE437	CP500		
	1	MN06121							5 7/8	6 1/4	RC750	RE750	CP750		
3¼	1	MN06130	1 1/4	3/4	5/8	1 7/8	1 1/4	7/8	6 7/8	7 1/2	RC750	RE750	CP750		
	1 3/8	MN06131							7 1/8	7 3/4	RC1000	RE1000	CP1000		
4	1	MN06140	1 1/4	3/4	5/8	1 7/8	1 1/4	7/8	6 7/8	7 1/2	RC750	RE750	CP750	EB750	CB750
	1 3/8	MN06141							7 1/8	7 3/4	RC1000	RE1000	CP1000		
5	1	MN06150	1 1/4	3/4	5/8	1 7/8	1 1/4	7/8	7 1/8	7 3/4	RC750	RE750	CP750		
	1 3/8	MN06151							7 3/8	8	RC1000	RE1000	CP1000		
6	1 3/8	MN06160	1 1/2	1	3/4	2 1/4	1 1/2	1	8 1/8	8 7/8	RC1000	RE1000	CP1000	EB1000	CB1000
	1 3/4	MN06161							8 3/8	9 1/8	RC1250	RE1250	CP1375		
8	1 3/8	MN06180	1 1/2	1	3/4	N/A	1 1/2	1	8 1/4	N/A	RC1000	RE1000	CP1000		
	1 3/4	MN06181							8 1/2	N/A	RC1250	RE1250	CP1375		
10	1 3/4	MN61100	2	1 3/8	1	N/A	2 1/8	1 3/8	10 3/8	N/A	RC1250	RE1250	CP1375	EB1375	CB1375
	2	MN61101							10 1/2	N/A	RC1500	RE1500	CP1750		
12	2	MN61200	2 1/2	1 3/4	1 1/4	N/A	2 1/4	1 3/4	11 1/8	N/A	RC1500	RE1500	CP1750	EB1750	CB1750
	2 1/2	MN61201							11 3/8	N/A	RC1875	N/A	CP2000		

Clevis pins are provided with pivot mounts. For dimensions not shown, see page 105.

\*\*Extruded MP1 mounts are standard (1½" - 8" bores). Cast Iron removable mounts are optional, and must be requested when ordering (1½" - 6" bores). Specify "CAST MP1" when ordering.

Series H

Series MH

Series LH

Series A

Series MN

**Rod End Styles and Dimensions**  
For rod end styles and dimensions see:  
Page 105

## DOUBLE ROD END CYLINDERS

- Standard and oversize piston rods available
- Full range of standard options
- Durable design. Full rod bearing at each end of cylinder
- Can be provided with hollow piston rods (gun-drilled through, to your size requirements)
- Can be used in adjustable extend stroke applications (by adding a stop collar on one rod end, or option "MA" - Refer to page 119).

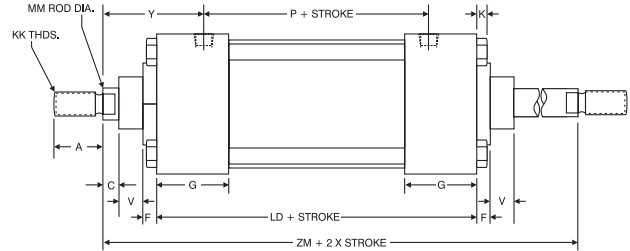
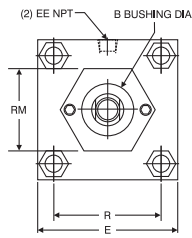
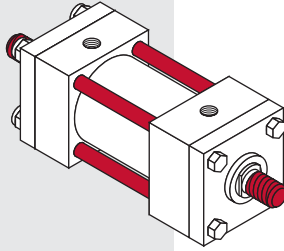

Bore Ø	Rod MM	Cylinder Code	A	B	C	E	EE	F	G	K	KK	LD	P	R	RM	V	Y	ZM
1½	5/8	DMN00611	¾	1 1/8	¾	2	¾	¾	1 1/2	¼	7/16-20	4 1/8	2 3/8	1.43	2 Sq.	¼	1 7/8	6 1/8
	1	DMN00612	1 1/8	1 1/2	1/2						¾-16					1/2	2 1/4	6 7/8
2	5/8	DMN06110	¾	1 1/8	¾	2 1/2	¾	¾	1 1/2	5/16	7/16-20	4 1/8	2 3/8	1.84	1 3/4 Hex	¼	1 7/8	6 1/8
	1	DMN06111	1 1/8	1 1/2	1/2						¾-16					1/2	2 1/4	6 7/8
2½	5/8	DMN06120	¾	1 1/8	¾	3	¾	¾	1 1/2	5/16	7/16-20	4 1/4	2 1/2	2.19	1 3/4 Hex	¼	1 7/8	6 1/4
	1	DMN06121	1 1/8	1 1/2	1/2						¾-16					1/2	2 1/4	7
3¼	1	DMN06130	1 1/8	1 1/2	1/2	3 3/4	1/2	5/8	1 3/4	¾	¾-16	4 3/4	2 3/4	2.76	2 3/4 Dia.	¼	2 3/8	7 1/2
	1 3/8	DMN06131	1 5/8	2	5/8						1-14					3/8	2 5/8	8
4	1	DMN06140	1 1/8	1 1/2	1/2	4 1/2	1/2	5/8	1 3/4	¾	¾-16	4 3/4	2 3/4	3.32	2 3/4 Dia.	¼	2 3/8	7 1/2
	1 3/8	DMN06141	1 5/8	2	5/8						1-14					3/8	2 5/8	8
5	1	DMN06150	1 1/8	1 1/2	1/2	5 1/2	1/2	5/8	1 3/4	7/16	¾-16	5	3	4.10	2 3/4 Dia.	¼	2 3/8	7 3/4
	1 3/8	DMN06151	1 5/8	2	5/8						1-14					3/8	2 5/8	8 1/4
6	1 3/8	DMN06160	1 5/8	2	5/8	6 1/2	¾	5/8	2	7/16	1-14	5 1/2	3 1/4	4.88	3 1/2 Dia.	3/8	2 3/4	8 3/4
	1 3/4	DMN06161	2	2 3/8	¾						1 1/4-12					1/2	3	9 1/4
8	1 3/8	DMN06180	1 5/8	2	5/8	8 1/2	¾	5/8	2	9/16	1-14	5 5/8	3 3/8	6.44	3 1/2 Dia.	3/8	2 3/4	8 7/8
	1 3/4	DMN06181	2	2 3/8	¾						1 1/4-12					1/2	3	9 3/8
10	1 3/4	DMN61100	2	2 3/8	¾	10 5/8	1	5/8	2 1/4	1 1/16	1 1/4-12	6 5/8	4 5/16	7.92	3 1/2 Dia.	1/2	3 1/16	10 3/8
	2	DMN61101	2 1/4	2 5/8	7/8			¾			1 1/2-12					3/8	3 3/16	10 5/8
12	2	DMN61200	2 1/4	2 5/8	7/8	12 3/4	1	¾	2 1/4	1 1/16	1 1/2-12	7 1/8	4 1 3/16	9.40	5 Dia.	3/8	3 3/16	11 1/8
	2 1/2	DMN61201	3	3 1/8	1						1 7/8-12					1/2	3 7/16	11 5/8

### ▼ Double Rod End Stroke Adders

Bore Ø	Rod MM	MS1D		MS2D
		SAD	XAD	SSD
1½	5/8	6 7/8	6 1/2	3 3/8
	1		6 7/8	
2	5/8	6 7/8	6 1/2	3 3/8
	1		6 7/8	
2½	5/8	7	6 5/8	3 1/2
	1		7	
3¼	1	8 1/2	8	3 3/4
	1 3/8		8 1/4	
4	1	8 1/2	8	3 3/4
	1 3/8		8 1/4	
5	1	9	8 3/8	3 5/8
	1 3/8		8 5/8	
6	1 3/8	9 3/4	9 1/4	4 1/8
	1 3/4		9 1/2	
8	1 3/8	9 1/4	9 1/16	4 1/4
	1 3/4		9 5/16	

## INDEX TO BASIC OPTIONS

CODE	DESCRIPTION	
A=	EXTENDED PISTON ROD THREAD . . . . .	114
A/O	AIR/OIL PISTON . . . . .	114
AS	ADJUSTABLE STROKE (RETRACT) . . . . .	114
B, BC, BH	BUMPERS . . . . .	114
BP	BUMPER PISTON SEALS . . . . .	115
H, C, LH, LC, ELH, ELC	CUSHIONS . . . . .	116
ELH, ELC	DIMENSIONS FOR EXTRA LONG CUSHIONS . . . . .	117
	CUSTOM LENGTH CUSHIONS . . . . .	117
BSPT/BSPP	BRITISH STANDARD PIPE THREADS. . . . .	118
C=	EXTENDED PISTON ROD . . . . .	118
EN	ELECTROLESS NICKEL . . . . .	118
KK3S	STUDDED PISTON ROD . . . . .	118
LF	LOW FRICTION . . . . .	118
MA	MIXCRO-ADJUST . . . . .	119
MAB	MICRO-ADJUST WITH URETHANE BUMPER . . . . .	119
MPR, MPH	MAGNETIC PISTON . . . . .	120
MS	METALLIC ROD SCRAPER . . . . .	120
NR	NON-ROTATING (NFPA) CYLINDERS . . . . .	120
OP	OPTIONAL PORT LOCATION . . . . .	121
	OPTIONAL PORT & CUSHION AT SAME LOCATION . . . . .	121
OS	OVERSIZE ROD . . . . .	121
SAE	SAE "O-RING" BOSS PORTS . . . . .	121
SSA	STAINLESS STEEL "ALL" . . . . .	122
SSF	STAINLESS STEEL FASTENERS . . . . .	122
SSR	STAINLESS STEEL PISTON ROD . . . . .	122
SST	STAINLESS STEEL TIE RODS & NUTS . . . . .	122
ST	STOP TUBE . . . . .	122
TH	400 PSI HYDRAULIC (NON SHOCK) . . . . .	123
VS	VITON . . . . .	123

**A=**

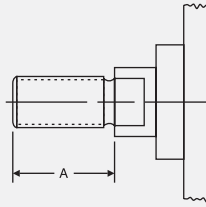

**EXTENDED PISTON ROD THREAD**

"A=" Refers to the length of piston rod thread  
 Shorter than standard lengths can be furnished at no charge. Longer than standard lengths can be furnished at nominal price adder.  
*Special length threads available.*

**A/O**

**AIR/OIL PISTON**

Air/Oil pistons allow for the combination of pneumatic supply air with the precise control of oil.  
 The basic A/O piston is designed for oil on the cylinder cap end, and a "meter out" flow control (not provided) for precise return stroke control.  
 For applications that require the oil to be on the cylinder rod end, specify the TH option.  
 NOTE: Due to the nature of oil to remain in the tubing finish recesses, a condition called "collaring" will allow oil to seep past the A/O seal over time, escaping in the air valve exhaust.

**AS**

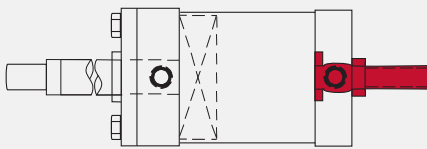

**ADJUSTABLE STROKE (RETRACT)**

Consists of a threaded rod in the cylinder cap, non-removable. Provides an adjustable positive stop on the cylinder retract.  
*To order, specify "AS" and length of adjustment (Example: AS=3").*

**B, BC, BH**

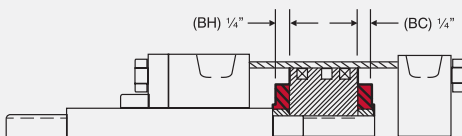

**BUMPERS**

Urethane impact dampening bumpers, used when cylinder speeds do not allow for standard cushions.  
**BC** = Cap Bumper **BH** = Head Bumper **B** = Head and Cap Bumper  
 (NOTE: Each bumper adds 1/4" to cylinder length).

**BP**

## BUMPER PISTON SEALS

*Milwaukee Cylinder's Bumper Piston Seal*, when used with our advanced cushion design, decelerates the cylinder at end of stroke — reducing noise and extending cylinder life.



1½" Bore Shown



Available on 1½" - 8" Bore

### BENEFITS

- **Reduces cycle rates**  
Higher piston velocities can be achieved due to rapid deceleration feature increasing productivity
- **Provides maximum impact dampening**  
Reduces machine vibration
- **Reduces cylinder end-of-stroke noise**
- **Available in Viton Seals**  
(1½" to 8" bore)

### DESIGN TIPS

- Use cushions to achieve quick performance on longer strokes (Options HC & BP)
- Use the BP Seals without cushions on short strokes requiring fast cycles
- Due to compressibility, BP Seals are not recommended for applications that require 100% repeatable stroke increments

**Bumper Piston Seals will shorten the cylinder stroke when operated at less than 90 PSI supply air.** The charts below show the approximate (average) stroke reduction, at various pressure (for new cylinders). As the cylinders are cycled, the seals will take a slight set. Tests have shown that after 1,500,000 cycles, the seals will have between .001" and .008" compression set per seal. After that, there is no noticeable compression set.

TOTAL STROKE REDUCTION ("A" Dimension X 2) (in inches)						
Bore Ø	0 PSI	10 PSI	30 PSI	50 PSI	70 PSI	90 PSI
1½	.10	.09	.07	.06	.04	.00
2	.14	.11	.07	.04	.01	.00
2½	.18	.14	.08	.05	.02	.00
3¼	.14	.12	.08	.04	.01	.00
4	.17	.14	.09	.05	.02	.00
5	.18	.14	.07	.03	.01	.00
6	.23	.18	.10	.05	.01	.00
8	.31	.26	.15	.07	.03	.00

PER END STROKE REDUCTION ("A" Dimension) (in inches)						
Bore Ø	0 PSI	10 PSI	30 PSI	50 PSI	70 PSI	90 PSI
1½	.048	.043	.035	.028	.021	.00
2	.069	.056	.037	.020	.010	.00
2½	.091	.070	.042	.024	.008	.00
3¼	.071	.059	.039	.020	.002	.00
4	.087	.069	.045	.026	.009	.00
5	.092	.072	.036	.013	.005	.00
6	.113	.091	.051	.023	.003	.00
8	.154	.132	.076	.037	.016	.00

Standard Material: Buna-N  
Optional Material: Viton

Operating Temperature:  
**-20° F to 200° F**

Operating Temperature:  
**-150° F to 350° F**

Operating Pressure:  
**250 PSI Air**

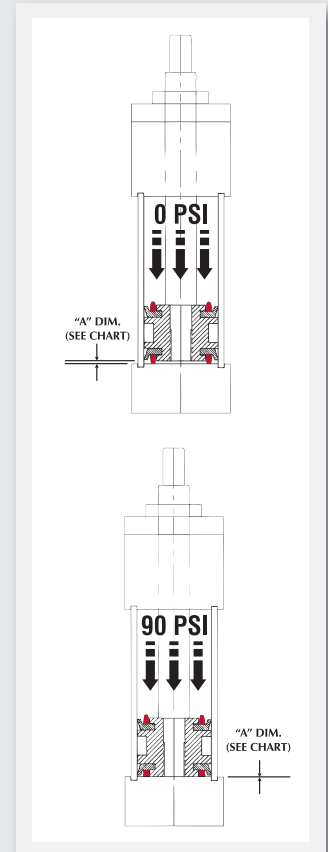

Series H

Series MH

Series LH

Series A

Series MN

## Seal Design



Front Side



Back Side

## HEAD AND CAP CUSHIONS

Milwaukee Cylinder's advanced cushion design features a unique, one piece seal that is allowed to float in a precision machined groove.

This type of seal design provides consistent cushion performance and maximum seal life.

Oversized flow paths molded in the periphery of the seal provide "full flow" on the return stroke without the use of ball checks.

### HEAD CUSHIONS

**H** STANDARD LENGTH HEAD CUSHION

**LH** LONG HEAD CUSHION

**ELH** EXTRA LONG HEAD CUSHION\*

\* Extra Long Head add length to cylinder.  
Refer to page 117 for details.\*

### CAP CUSHIONS

**C** STANDARD LENGTH CAP CUSHION

**LC** LONG CAP CUSHION

**ELC** EXTRA LONG CAP CUSHION\*

\* Extra Long Head add length to cylinder.  
Refer to page 117 for details.\*

## HOW TO SIZE CUSHIONS FOR YOUR APPLICATION

Cylinders with air cushions provide a possible solution to destructive energies. The air cushion traps a small amount of exhaust air at the end of stroke, providing an air pocket that decelerates the load. This reduces the potentially destructive energy being transmitted to the cylinder and other components. The following is a brief explanation on how to determine the energy level of your application and determine if an air cushion can provide adequate energy absorption. Air cushions do not build heat since the heat generated is dissipated with the exhausted air flow.

- STEP 1:** Determine the total load to be stopped by the cylinder. Include the piston rod weight (see piston rod weight chart below).
- STEP 2:** Determine the velocity (in feet per second) at which the load impacts the cylinder end caps.
- STEP 3:** Use the following formula to calculate the energy the cylinder generates.
- STEP 4:** Using the table below, select the proper cushion length. Note: You can choose a larger bore size to increase cushion capacities.

## CUSHION SIZING FORMULA

Milwaukee Cylinder's advanced cushion design features a unique, one piece seal that is allowed to float in a precision machined groove.

$$\text{energy} = \frac{(w \times v^2) + (p \times k)}{64}$$

W = Total weight of load in pounds (including piston rod)

V = Velocity (in feet per second)

P = Driving pressure in PSI (usually the air line pressure)

K = Bore constant value (see chart below for "K" values)

### Sizing Example:

How to figure the energy for a 2½" bore cylinder, 10" stroke, 5/8" piston rod, moving a 25 lb. load at 6 feet per second with 80 psi air.

P = 80 psi W = 26.25 lbs. V = 6 FPS. K = .17

Energy = (26.25/64) X (62) or (36) + (80 X .17)

Energy = 28.36 ft/lbs.

The Maximum Energy Data Chart indicates that the "Long" Cushion at 38.6 maximum energy value would be the right choice for this application.

### Design Tips



- Cushions Adjustment screws can be ordered on same side as ports. Refer to page 121 for details.

same side as ports. Refer to page 121 for details.

- BP Seals provide additional impact dampening and noise reduction. (Refer to page 145 for details).

### Piston Rod Weight Chart

Rod MM	Piston Rod Weight*
5/8	.35 lb. + .09 lb/in of stroke
1	1.1 lb. + .22 lb/in of stroke
1 1/8	2.3 lb. + .42 lb/in of stroke
1 3/4	5.0 lb. + .68 lb/in of stroke
2	6.1 lb. + .88 lb/in of stroke
2 1/2	10.4 lb. + 1.39 lb/in of stroke

\* Double weight for double rod end cylinders.

### MAXIMUM ENERGY DATA

Bore Ø	K	H OR C Standard Cushion Series Max Energy (ft-lbs)	LH OR LC Long Cushion Series Max Energy (ft-lbs)	ELH OR ELC Extra-Long Cushion Series Max Energy (ft-lbs)
1 1/2	.06	8.2	12.8	26.9
2	.11	13.8	21.7	45.8
2 1/2	.17	24.6	38.6	81.5
3 1/4	.25	45.7	83.6	172.2
4	.38	57.3	137.1	282.6
5	.59	94.6	226.0	465.8
6	1.37	225.5	334.4	767.6
8	2.43	411.3	609.8	1399.8
10	3.79	379.4	621.4	1620.9
12	5.47	554.8	908.8	2370.6

## EXTRA LONG CUSHIONS

Milwaukee Cylinder's "ELH" Extra-Long Head Cushions and "ELC" Extra-Long Cap Cushions add length to the cylinder. Refer to the chart for dimensions.

**ELH** EXTRA LONG HEAD CUSHION

**ELC** EXTRA LONG CAP CUSHION

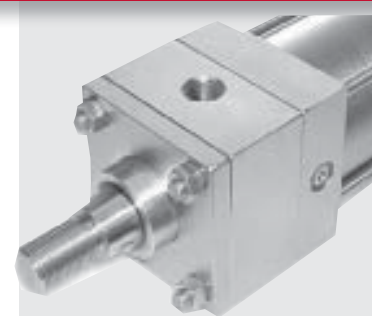
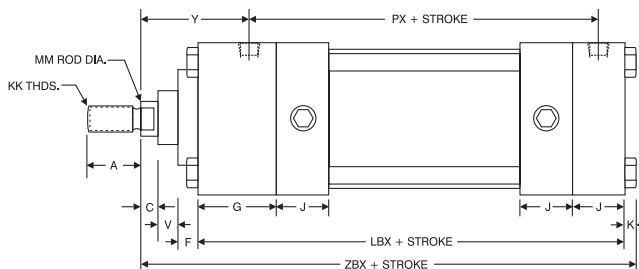
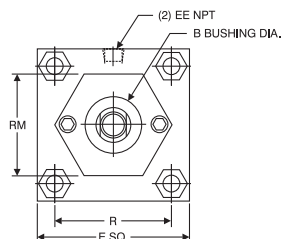

(MN41-1 1/2" X 6" ELH - EN) Shown

Bore Ø	Rod MM	Cylinder Code	A	B	C	E	EE	F	G	J	K	KK	LBX	PX	R	RM	V	Y	ZBX
1 1/2	5/8	DMN00611	3/4	1 1/8	3/8	2	3/8	3/8	1 1/2	1	1/4	7/16-20	5 5/8	4 3/8	1.43	2 Sq.	1/4	1 7/8	6 7/8
	N/A	DMN00612	N/A	N/A	N/A							N/A					N/A	N/A	N/A
2	5/8	DMN06110	3/4	1 1/8	3/8	2 1/2	3/8	3/8	1 1/2	1	5/16	7/16-20	5 5/8	4 3/8	1.84	1 3/4 Hex	1/4	1 7/8	6 15/16
	1	DMN06111	1 1/8	1 1/2	1/2							3/4-16				2 1/2 Sq.	1/2	2 1/4	7 5/16
2 1/2	5/8	DMN06120	3/4	1 1/8	3/8	3	3/8	3/8	1 1/2	1	5/16	7/16-20	5 3/4	4 1/2	2.19	1 3/4 Hex	1/4	1 7/8	7 1/16
	1	DMN06121	1 1/8	1 1/2	1/2							3/4-16				3 Sq.	1/2	2 1/4	7 7/16
3 1/4	1	DMN06130	1 1/8	1 1/2	1/2	3 3/4	1/2	5/8	1 3/4	1 1/4	3/8	3/4-16	6 3/4	5 1/4	2.76	2 3/4 Dia.	1/4	2 3/8	8 1/2
	1 3/8	DMN06131	1 5/8	2	5/8							1-14				3 3/4 Sq.	3/8	2 5/8	8 3/4
4	1	DMN06140	1 1/8	1 1/2	1/2	4 1/2	1/2	5/8	1 3/4	1 1/4	3/8	3/4-16	6 3/4	5 1/4	3.32	2 3/4 Dia.	1/4	2 3/8	8 1/2
	1 3/8	DMN06141	1 5/8	2	5/8							1-14				3 1/2 Dia.	3/8	2 5/8	8 3/4
5	1	DMN06150	1 1/8	1 1/2	1/2	5 1/2	1/2	5/8	1 3/4	1 1/4	7/16	3/4-16	7	5 1/2	4.10	2 3/4 Dia.	1/4	2 3/8	8 13/16
	1 3/8	DMN06151	1 5/8	2	5/8							1-14				3 1/2 Dia.	3/8	2 5/8	9 1/16
6	1 3/8	DMN06160	1 5/8	2	5/8	6 1/2	3/4	5/8	2	1 1/2	7/16	1-14	8	6 1/4	4.88	3 1/2 Dia.	3/8	2 3/4	10 1/16
	1 3/4	DMN06161	2	2 3/8	3/4							1 1/4-12					1/2	3	10 5/16
8	1 3/8	DMN06180	1 5/8	2	5/8	8 1/2	3/4	5/8	2	1 1/2	9/16	1-14	8 1/8	6 3/8	6.44	3 1/2 Dia.	3/8	2 3/4	10 5/16
	1 3/4	DMN06181	2	2 3/8	3/4							1 1/4-12					1/2	3	10 5/16
10	1 3/4	DMN61100	2	2 3/8	3/4	10 5/8	1	5/8	2 1/4	2	1 1/16	1 1/4-12	10 3/8	8 5/16	7.92	3 1/2 Dia.	1/2	3 1/16	12 15/16
	2	DMN61101	2 1/4	2 5/8	7/8							1 1/2-12					3/8	3 3/16	13 1/16
12	2	DMN61200	2 1/4	2 5/8	7/8	12 3/4	1	3/4	2 1/4	2	1 1/16	1 1/2-12	10 7/8	8 13/16	9.40	5 Dia.	3/8	3 3/16	13 9/16
	2 1/2	DMN61201	3	3 3/8	1							1 7/8-12					1/2	3 7/16	10 13/16

## EXTRA LONG CUSHIONS

Custom length cushions can be designed for your application. Contact Milwaukee Cylinder for details!

Example: An OEM manufacturer of industrial equipment needed a cylinder to shuttle a 125 lb. rolling (and guided) fixture 36" of travel, at low airline pressure to avoid operator injury. A 3 1/2" long head and cap cushion was designed to meet the operating specifications.





## BSPT

### BRITISH STANDARD PIPE TAPER

British Standard Pipe Taper (**BSPT**) threads have the same taper as American NPT tapered threads, but use a 55° Whitworth thread form and different diameters. *(Not interchangeable with NPT)*

## BSPP

### BRITISH STANDARD PIPE PARALLEL

British Standard Pipe Parallel (**BSPP**) also referred to as BSP "Straight" Thread. *(Not interchangeable with NPT)*

## C=

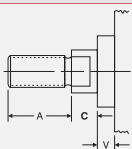

### EXTENDED PISTON ROD

"C=" is commonly referred to as Piston Rod Extension. Piston rods can be extended to any length up to 120" total piston rod length, including stroke portion. Cylinders with long "C" lengths can be mounted away from obstacles or outside hazardous environments.

## EN

### ELECTROLESS NICKEL

"EN" or Electroless Nickel plating was invented in 1946, and has gained worldwide commercial usage since 1964. Common usages include aircraft landing gear, automotive brake cylinder and components, fuel injector parts, gas turbine parts, spray nozzles for chemical applications and many electronic devices including hard drives.

The properties of Electroless Nickel contribute to the multitude of uses. The coating provides an attractive finish, while exhibiting high abrasion and corrosion resistance. Its ability to uniformly coat blind holes, threads, internal surfaces and sharp edges contributes to its effectiveness. It has a very high bonding strength to the base metal (100,000-200,000 psi), so much so that gas turbines use electroless nickel plating as a base to braze broken blades to.

#### COMMON USAGES:

- **FOOD PROCESSING** — EN plating has been used to handle such diverse products as sodium hydroxide, food grade acids and fish oils. Excellent resistance to mild sanitizing caustics, chlorine, and chlorides in general. The natural smooth finish ensures cleanliness in food processing equipment.
- **PETROLEUM AND CHEMICAL** — The petroleum and chemical industry are large users of electroless nickel plating for corrosion protection. Design tip: Submit the list of chemicals and concentration levels to *Milwaukee Cylinder* for evaluation and recommendations. In some instances, Stainless Steel cylinders provide the best value and long cylinder life.
- **MEDICAL AND PHARMACEUTICAL** — The medical industry uses EN plated cylinders in clean-rooms, on equipment used to make plasma or IV bags, since it is critical that cylinder components need to be sterilized and particle "flake free". The pharmaceutical industry typically can be harsh on equipment, even abusive – but the equipment must remain completely reliable. EN cylinders provide the most reliable and cost effective choice.

#### EN CYLINDER SPECIFICATIONS

##### En Plated Parts:

Tube, Head, Cap, Bushing Retainer, Mounts (excluding MT1/MT2 which is hard chrome plated stainless steel).

##### Other Components:

303/304 Stainless Steel: Tie Rods & Nuts, Retainer Screws, Piston Rod (hard chrome plated), Rod Bushing with PTFE Wear Band and Rod Wiper. (Optional: SAE 660 Bronze Rod Bushing)

#### EN PLATING SPECIFICATIONS:

**High Phosphorus** (highest corrosion resistant Electroless Nickel plating available)

**Composition:** 87-90% Nickel, 10-13% Phosphorus

**Hardness:** Rc 46-48

**Thickness:** .0005"-.0007"

**Lubricity:** Excellent (Similar to chrome)

**Coefficient Of Friction:** Low

**Finish:** Bright and very smooth

Other types of EN plating are available. Contact *Milwaukee Cylinder* with your specifications for a prompt quote.

## KK35

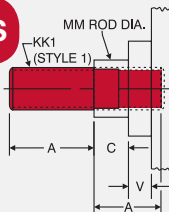

### STUDED PISTON ROD

**KK35** option combines the KK3 female threaded rod end design and a stud, with permanent Loctite. When assembled, the KK35 has the same dimensions as a KK1 rod end.

This option is useful in applications that typically break standard KK1 rod ends due to high load impacting.

## LF

### LOW FRICTION

**Material:** Carboxylated Nitrile  
**Operating Temp.:** -20°F to 200°F  
**Operating Pressure:** 250 psi Air

"LF" Low Friction option incorporates the use of round-lip, extremely low friction carboxylated nitrile seals. Round-lip seals "hydroplane" on opposed sealing surfaces, and have a lower running and break-away friction. • **Material:** Carboxylated Nitrile • **Operating Temperature:** -20°F to 200°F (-25°C to 90°C) • **Operating Pressure:** 250 psi air (17 bar)

**MA**



**MICRO-ADJUST**

- Allows precise adjustment of cylinder extend stroke
- Easy to read precision scale (.001" calibration)
- Enclosed, no "pinch point" design
- Available on all cylinder models with "D" Double Rod End option
- Up to 6" stroke and adjustment\*

\* Note: The adjustment range is throughout entire stroke. Consult factory for longer stroke requirements or modifications not listed.

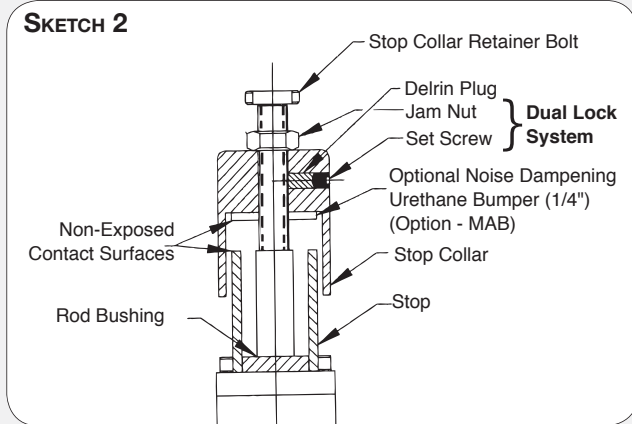
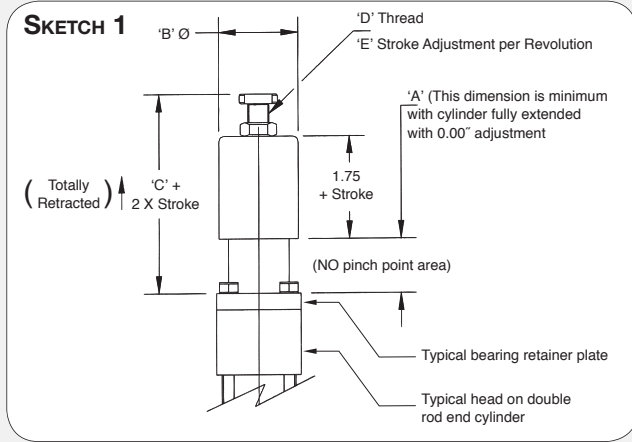

- MICRO-ADJUST Set-up Instructions**
- 1) Set actuator to desired stroke
  - 2) Turn stop collar until it makes contact with stop
  - 3) Tighten set screw
  - 4) Tighten jam nut for positive lock of stop collar

MICRO-ADJUST DIMENSIONS					
Bore Ø	A	B	C	D	E
1½	1.00	1.88	3.71	½-20	.050
2	1.00	1.88	3.71	½-20	.050
2½	1.00	1.88	3.71	½-20	.050
3¼	1.00	2.81	3.71	¾-16	.063
4	.75	2.81	3.47	¾-16	.063
5	.75	2.81	3.47	¾-16	.063
6	.75	3.75	3.47	¾-16	.063
8	.75	3.75	3.47	¾-16	.063

**MAB**

**MICRO-ADJUST WITH URETHANE BUMPER**

A noise dampening urethane bumper is added between the metal contact points, minimizing noise. See Sketch 2 above.

## MPR/MPH

### MAGNETIC PISTON

**MPR** Magnetic Pistons are used in conjunction with Milwaukee Cylinder's R10, R10P, RAC Reed and MSS Solid State Switches. (See pages 127-133 for switches)

**MPH** Magnetic Pistons are used with Milwaukee Cylinder's "Old Style" HE011, HE03SK and HE04SC Hall Effect Switches.

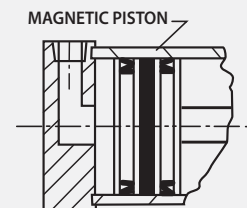

## MS

### METALLIC ROD SCRAPER

Aggressively scrapes the piston rod, removing foreign material such as spatter, sprays and powders. (Brass construction)

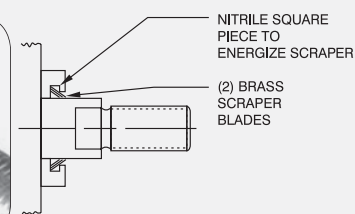
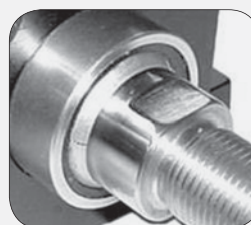

## NR

### NON-ROTATING (NFPA) CYLINDERS

2" through 12" bore 200 psi air, 400 psi hydraulic (non-shock)

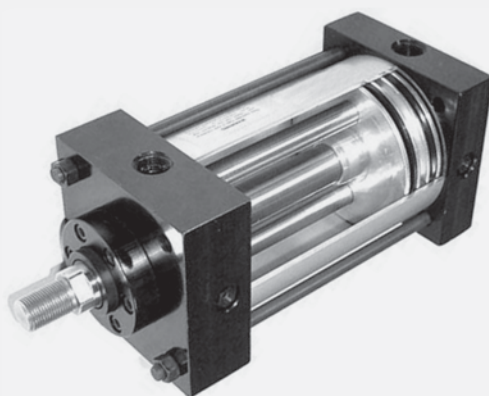

#### Benefits:

- Two internal guide rods throughout stroke
- High repeatability at each end of stroke (+/- 1 degree)
- All external dimensions are the same as standard cylinder (no additional length or width required)
- Standard Diameter Guide Rod Seals & Bronze Bearings for long life and reliable operation
- Available in Double Rod End Models

#### Advantages

- Eliminates the need for external guide shafts in many positioning applications
- Guide rods are internal, self-cleaning, not subjected to harsh cleaners
- Compact design saves space, no larger than standard NFPA cylinders!
- Durable, self-contained construction

Note: "NR" option not available in combination with "BP" bumper piston seal option.

'NR' GUIDE ROD SIZES AND MAX. STROKE

Bore Ø	Rod MM	Cushions	Guide Rod Ø	Max. Stroke (inches)
2	5/8	Cap only	0.250	10
2½	5/8	Cap only	0.312	12
	1	N/A	0.312	12
3¼	1	Available	0.375	18
	1⅜	Cap only	0.375	18
4	1	Available	0.625	30
	1⅝	Available	0.625	30
5	1	Available	0.625	30
	1⅜	Available	0.625	30
6	1⅜	Available	0.625	30
	1¾	Available	0.625	30
8	1⅜	Available	1.000	40
	1¾	Available	1.000	40
10	1¾	Available	1.000	40
	2	Available	1.000	40
12	2	Available	1.000	40
	2½	Available	1.000	40

#### APPLICATION POSSIBILITIES:

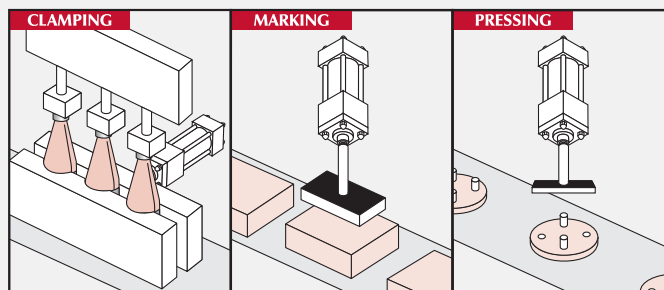

## OP

### OPTIONAL PORT LOCATION

Optional port locations can be ordered simply by calling out the location numbers:

Note: When optional port locations are ordered, specify **both** port locations, even if one port is in the standard location.

- Standard port positions at 1
- Standard cushion positions at 2
- Specify non-standard locations when ordering

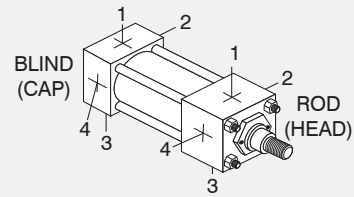

### OPTIONAL PORT AND CUSHION AT SAME LOCATION

Now available, the ability to specify Ports and Cushions on the same cylinder side!

Note: When optional port and cushion locations are ordered, specify both port and cushion locations, even if a port or cushion is in the standard location.



### BASIC DIMENSIONS:

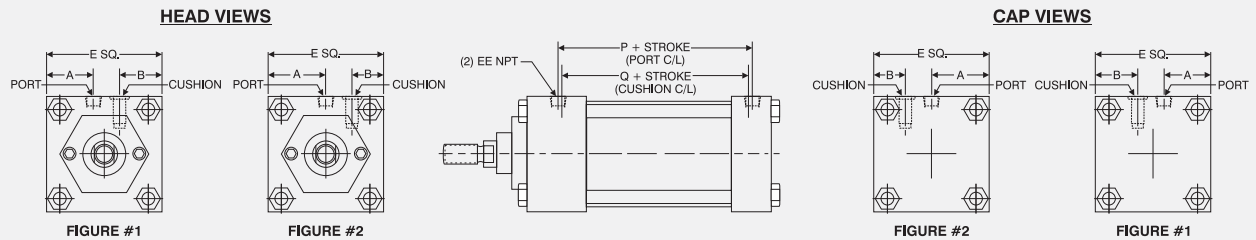

Bore Ø	Rod MM	Figure	A	B	E	EE	P	Q
1½	5/8	1	3/4	5/8	2	1/4	2 3/8	2 1/8
	1	N/A	N/A	N/A	N/A			
2	5/8	1	7/8	15/16	2 1/2	3/8	2 3/8	2 1/8
	1	1	1	3/4	2 1/2			
2½	5/8	1	1 1/8	1 1/8	3	3/8	2 1/2	2 1/4
	1	1	1 1/8	1	3			
3¼	1	1	1 1/2	1 3/8	3 3/4	1/2	2 3/4	2 1/2
	1 3/8	2	1 7/8	1	3 3/4			
4	1	2	2 1/4	1 1/4	4 1/2	1/2	2 3/4	2 1/2
	1 3/8	2	2 1/4	1 1/8	4 1/2			
5	1	2	2 3/4	1 3/4	5 1/2	1/2	3	3
	1 3/8	2	2 3/4	1 5/8	5 1/2			
6	1 3/8	2	3 1/4	1 7/8	6 1/2	3/4	3 1/4	3
	1 3/4	2	3 1/4	1 7/8	6 1/2			
8	1 3/8	2	4 1/4	2 3/4	8 1/2	3/4	3 3/8	3 1/8
	1 3/4	2	4 1/4	2 3/4	8 1/2			
10	1 3/4	2	5 5/16	3 11/16	10 5/8	1	4 5/16	4 1/8
	2	2	5 5/16	3 11/16	10 5/8			
12	2	2	6 3/8	4 3/4	12 3/4	1	4 13/16	4 5/8
	2 1/2	2	6 3/8	4 3/4	12 3/4			

## OS

### OVERSIZE ROD

Applications requiring long strokes may require oversize piston rod diameters to prevent sagging or buckling. To determine the recommended rod diameter, refer to Chart 3 on page 122.

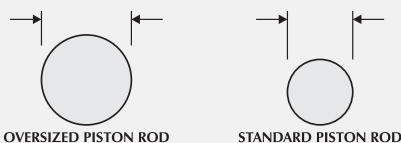

OVERSIZED PISTON ROD

STANDARD PISTON ROD

## SAE

### SAE "O"-RING BOSS PORTS (SAE J514)

SAE ports can be ordered in place of NPT ports. Order by SAE number. (Example SAE#10)

Recommended SAE Port Size by Cylinder Bore			
Bore Ø	SAE#	Bore Ø	SAE#
1½	#4 (7/16-20)	5	#6 (9/16-18)
2	#4 (7/16-20)	6	#8 (3/4-16)
2½	#4 (7/16-20)	8	#8 (3/4-16)
3¼	#6 (9/16-18)	10	#10 (7/8-14)
4	#6 (9/16-18)	12	#10 (7/8-14)

## STAINLESS STEEL

Stainless Steel, when used in conjunction with Anodized Aluminum Heads, Caps and Tube, provide corrosion resistance in outdoor applications and wet environments.

Customize your cylinder by choosing from Stainless Steel Fasteners, Piston Rod, or Tie Rods and Nuts.

### SSA

#### STAINLESS STEEL "ALL"

Stainless Steel Piston Rod (Hard-Chrome Plated), Stainless Steel Fasteners, Stainless Steel Tie Rods and Nuts

### SSF

#### STAINLESS STEEL FASTENERS

Stainless Steel Fasteners (Bushing Retainer Screws)

### SSR

#### STAINLESS STEEL PISTON ROD

Stainless Steel Piston Rod (Hard-Chrome Plated)

### SST

#### STAINLESS STEEL TIE RODS & NUTS

Stainless Steel Tie Rods and Nuts

### ST

#### STOP TUBE

Stop Tubes are designed to reduce the piston rod bushing stress to within the designed range of the bearing material. This will insure proper cylinder performance, in any given application. Stop Tubes lower the cylinder bearing stress by adding length to the piston, which increases the overall length of the cylinder. (Note: Milwaukee Cylinder uses a double piston design for 2-inch and longer stop tubes.)

#### Stop Tube Selection

To determine the proper amount of stop tube for your application, you must first find the value of "D", which represents the "stroke, adjusted for mounting condition". Each mounting condition creates different levels of bushing stress, which have direct impact on the amount of stop tube required. (See Chart 1)

Once the value of "D" is known, refer to Chart 2 for the recommended amount of stop tube.

To order a Stop Tube, add the stop tube prefix "ST=" and the length, to the end of your cylinder model number.

As noted, the working stroke must be included when ordering.

### Chart 1

Find the value of "D" for your application

"D" = Stroke, adjusted for mounting condition "T" = Axial thrust (refer to Chart 3)  
 "S" = Actual cylinder stroke

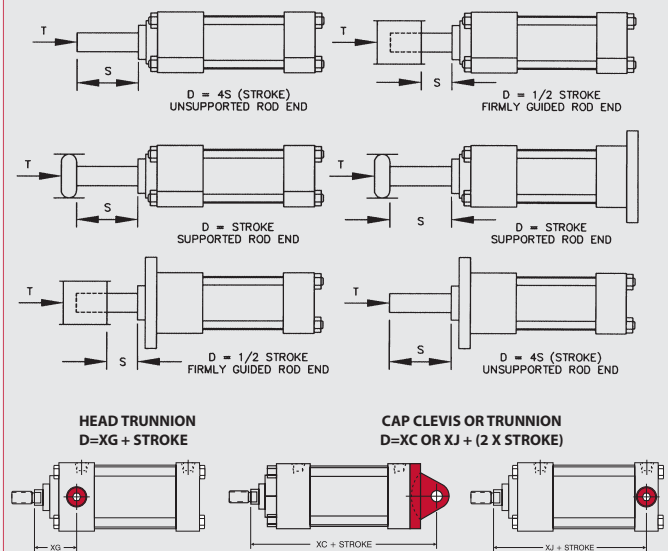

### Chart 2

Using the value of "D", find the recommended amount of stop tube

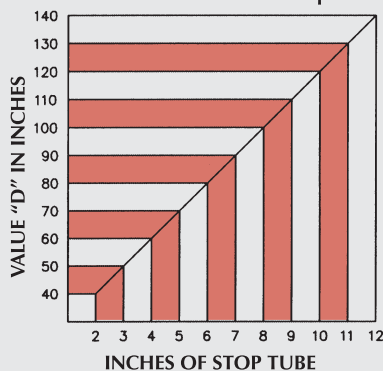

### Chart 3

ROD SIZE SELECTION

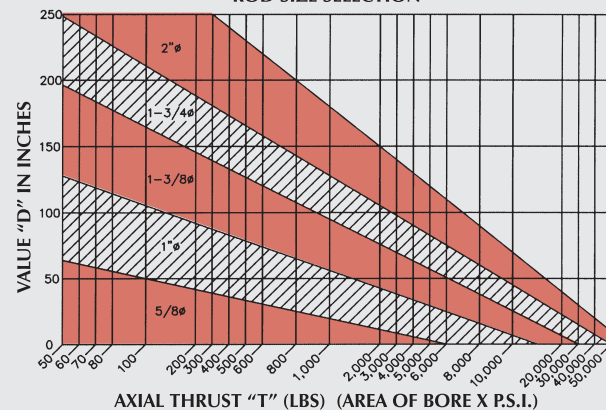

## TH

### 400 PSI HYDRAULIC (NON-SHOCK)

"MN" Series can be ordered with the "TH" option.

**RATING:** 400 PSI Hydraulic, Non-Shock

**SEALS:**

- Piston Seals - (1) POLY-PAK, (1) square-lip
- Rod Seal - POLY-PAK

## VS

### VITON SEALS

Benefits of VITON Seals:

- Higher temperature performance (0° F to 350° F [-20° C to 200° C])
- Higher chemical resistance (Resists most wash down solutions)

Many other seal materials are available. Contact *Milwaukee Cylinder* for proper seal material selection in tough applications or environments

Series H

Series MH

Series LH

Series A

Series MN

## ▼ ACCESSORIES CROSS REFERENCE CHART

CYLINDER MODEL				ACCESSORIES				
Bore Ø	Rod MM	Rod Style (KK)	Rod Thread	Rod Clevis	Rod Eye	Clevis Pin	Clevis Bracket	Eye Bracket
1½, 2, 2½	5/8	(Standard) KK1	7/16-20	RC437	RE437	CP500	CB500	EB500
		KK2	1/2-20	RC500	RE500	CP500		
	1	(Standard-Oversized) KK1	3/4-16	RC750	RE750	CP750	CB750	EB750
		KK4	1-14	RC1000	RE1000	CP1000		
3¼, 4, 5	1	(Standard) KK1	3/4-16	RC750	RE750	CP750	CB750	EB750
		KK4	1-14	RC1000	RE1000	CP1000		
	1¾	(Standard-Oversized) KK1	1-14	RC1000	RE1000	CP1000	CB750	EB750
		KK2	1¼-12	RC1250	N/A	CP1375		
6 and 8	1¾	(Standard) KK1	1-14	RC1000	RE1000	CP1000	CB1000	EB1000
		KK2	1¼-12	RC1250	N/A	CP1375		
	1¾	(Standard-Oversized) KK1	1¼-12	RC1250	N/A	CP1375	CB1000	EB1000
		KK2	1½-12	RC1500	N/A	CP1750		
10	1¾	(Standard) KK1	1¼-12	RC1250	RE1250	CP1375	CB1375	EB1375
		KK2	1½-12	RC1500	RE1500	CP1750	CB1750	EB1750
12	2	(Standard) KK1	1½-12	RC1500	RE1500	CP1750	CB1750	EB1750
		KK2	1½-12	RC1500	RE1500	CP1750	CB1750	EB1750

### CLEVIS PIN (with Bridge Pin - Standard)

Part No.	CD	H	HP	LH	LP
CP500	1/2	5/8	5/32	2¼	2¾/32
CP750	¾	15/16	5/32	3	2 <sup>27</sup> /32
CP1000	1	1¾	13/64	3½	3 <sup>5</sup> /16
CP1375	1¾	1¾	¼	5	4½
CP1750	1¾	2 <sup>9</sup> /64	¼	6	5½



**MATERIAL:** 1018 CRS  
**FINISH:** BLACK OXIDE

CLEVIS PIN (INCLUDES BRIDGE PIN)

### CLEVIS PIN (with Cotter Pin)

Part No.	CD	LH	LP
CP500C	1/2	2¼	1 <sup>15</sup> /16
CP750C	¾	3	2 <sup>23</sup> /32
CP1000C	1	3½	3 <sup>7</sup> /32
CP1375C	1¾	5	4¼
CP1750C	1¾	6	5½
CP2000C	2	6	5½

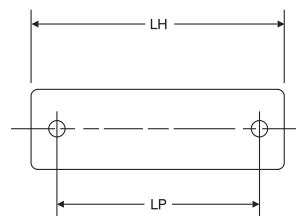

**MATERIAL:** 1045 CRS  
**FINISH:** CHROME PLATED O.D.

CLEVIS PIN (INCLUDES COTTER PINS)

HARD CHROME O.D.

CD + .000/- .001

### CLEVIS PIN (with E-Ring)

Part No.	CD	LH	LP
CP500E	1/2	2½	1 <sup>7</sup> /8
CP750E	¾	2 <sup>15</sup> /16	2 <sup>5</sup> /8
CP1000E	1	3 <sup>7</sup> /16	3½

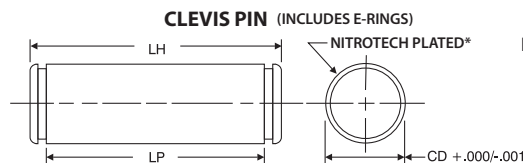

**MATERIAL:** 1045 CRS  
**FINISH:** NITROTECH PLATED\*

NITROTECH PLATED\*

\*Hard chrome plated O.D. available

### SMALL CLEVIS PIN (with Bridge Pin)

Part No.	CD	HP	LH	LP
CP500CCS	1/2	5/32	1¾	1¼
CP750CCS	¾	5/32	2	1 <sup>7</sup> /8

**MATERIAL:** 1018 CRS  
**FINISH:** BLACK OXIDE

SMALL CLEVIS PIN (INCLUDES BRIDGE PIN)

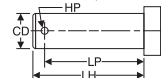

### SMALL ROD CLEVIS

Part No.	CB	CD	CE	CH	CW	KK1	KK2	L
RC437CCS	1/2	1/2	1¾	1	1/4	7/16-20	-	¾
RC500CCS	1/2	1/2	1¾	1	1/4	-	1/2-20	¾
RC750CCS	¾	¾	1¾	1½	¾	¾-16	-	1

**MATERIAL:** 1018 CRS  
**FINISH:** BLACK OXIDE

SMALL ROD CLEVIS

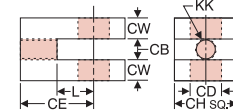

# MN Accessories: Clevis, Pins & Mounts

ROD CLEVIS								
Part No.	CB	CD	CE	CH	CW	ER	KK	L
RC437	3/4	1/2	1 1/2	1	1/2	1/2	7/16-20	3/4
RC500	3/4	1/2	1 1/2	1	1/2	1/2	1/2-20	3/4
RC750	1 1/4	3/4	2 3/8	1 1/4	5/8	3/4	3/4-16	1 1/4
RC1000	1 1/2	1	3 1/8	1 1/2	3/4	1	1-14	1 1/2
RC1250	2	1 3/8	4 1/8	2	1	1 3/8	1 1/4-12	2 1/8
RC1375	2	1 3/8	4 1/8	2	1	1 3/8	1 3/8-12	2 1/8
RC1500	2 1/2	1 3/4	4 1/2	2 3/8	1 1/4	1 3/4	1 1/2-12	2 1/4
RC1750	2 1/2	1 3/4	4 1/2	2 3/8	1 1/4	1 3/4	1 3/4-12	2 1/4
RC1875	2 1/2	2	5 1/2	3	1 1/4	2	1 7/8-12	2 1/2

**MATERIAL: CAST STEEL**  
**FINISH: BLACK OXIDE**

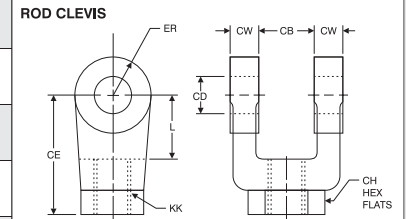

(Clevis Pins sold separately from Rod Clevises)

ROD EYE						
Part No.	A	CA	CB	CD	ER	KK
RE437	3/4	1 1/2	3/4	1/2	5/8	7/16-20
RE500	3/4	1 1/2	3/4	1/2	5/8	1/2-20
RE750	1 1/8	2 1/16	1 1/4	3/4	7/8	3/4-16
RE1000	1 5/8	2 13/16	1 1/2	1	1 3/16	1-14
RE1250	2	3 7/16	2	1 3/8	1 9/16	1 1/4-12
RE1500	2 1/4	4	2 1/2	1 3/4	2	1 1/2-12

**MATERIAL: 1018 CRS**  
**FINISH: BLACK OXIDE**

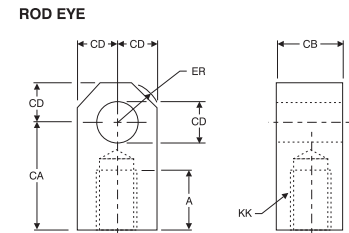

(Clevis Pins sold separately from Rod Eyes)

CLEVIS BRACKET										
Part No.	BA	CB	CD	CW	DD	E	F	FL	L	M
CB500	1 5/8	3/4	1/2	1/2	3/8-24	2 1/2	3/8	1 1/8	3/4	5/8
CB750	2 9/16	1 1/4	3/4	5/8	1/2-20	3 1/2	5/8	1 7/8	1 1/4	3/4
CB1000	3 1/4	1 1/2	1	3/4	5/8-18	4 1/2	3/4	2 1/4	1 1/2	1
CB1375	3 13/16	2	1 3/8	1	5/8-18	5	7/8	3	2 1/8	1 3/8
CB1750	4 15/16	2 1/2	1 3/4	1 1/4	7/8-14	6 1/2	7/8	3 1/8	2 1/4	1 3/4

**MATERIAL: CAST STEEL**  
**FINISH: BLACK OXIDE**

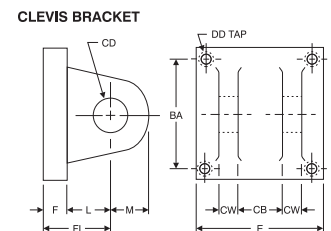

(Clevis Pins sold separately from Clevis Brackets)

EYE BRACKET										
Part No.	BA	CB	CD	DD	E	F	FL	L	M	
EB500	1 5/8	3/4	1/2	13/32	2 1/2	3/8	1 1/8	3/4	1/2	
EB750	2 9/16	1 1/4	3/4	17/32	3 1/2	5/8	1 7/8	1 1/4	3/4	
EB1000	3 1/4	1 1/2	1	2 1/32	4 1/2	3/4	2 1/4	1 1/2	1	
EB1375	3 13/16	2	1 3/8	2 1/32	5	7/8	3	2 1/8	1 3/8	
EB1750	4.95	2 1/2	1 3/4	29/32	6 1/2	7/8	3 1/8	2 1/4	1 3/4	

**MATERIAL: CAST STEEL**  
**FINISH: BLACK OXIDE**

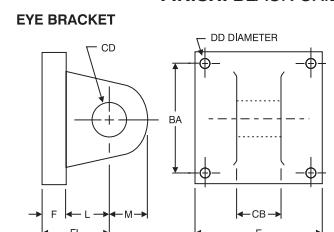

(Clevis Pins sold separately from Eye Brackets)



Series H

Series MH

Series LH

Series A

Series MN

## ▼ STAINLESS STEEL ACCESSORIES CROSS REFERENCE CHART

CYLINDER MODEL				ACCESSORIES				
Bore Ø	Rod MM	Rod Style (KK)	Rod Thread	Rod Clevis	Rod Eye	Clevis Pin	Clevis Bracket	Eye Bracket
1½, 2, 2½	5/8	(Standard)	KK1 7/16-20	SS-RC437	SS-RE437	SS-CP500	SS-CB500	SS-EB500
			KK2 ½-20	SS-RC500	SS-RE500	SS-CP500		
	1	(Standard-Oversized)	KK1 ¾-16	SS-RC750	SS-RE750	SS-CP750		
			KK4 1-14	SS-RC1000	SS-RE1000	SS-CP1000		
3¼, 4, 5	1	(Standard)	KK1 ¾-16	SS-RC750	SS-RE750	SS-CP750	SS-CB750	SS-EB750
			KK4 1-14	SS-RC1000	SS-RE1000	SS-CP1000		
	1¾	(Standard-Oversized)	KK1 1-14	SS-RC1000	SS-RE1000	SS-CP1000		
			KK2 1¼-12	SS-RC1250	N/A	SS-CP1375		
6 and 8	1¾	(Standard)	KK1 1-14	SS-RC1000	SS-RE1000	SS-CP1000	SS-CB1000	SS-EB1000
			KK2 1¼-12	SS-RC1250	N/A	SS-CP1375		
	1¾	(Standard-Oversized)	KK1 1¼-12	SS-RC1250	N/A	SS-CP1375		
			KK2 1½-12	SS-RC1500	N/A	SS-CP1750		

## ▼ ACCESSORIES (303 Stainless Steel)

CLEVIS PIN (with Cotter Pins)			
Part No.	CD	LH	LP
SS-CP500	½	2¼	1 <sup>15</sup> / <sub>16</sub>
SS-CP750	¾	3	2 <sup>23</sup> / <sub>32</sub>
SS-CP1000	1	3½	3 <sup>7</sup> / <sub>32</sub>
SS-CP1375	1¾	5	4¼
SS-CP1750	1¾	6	5½

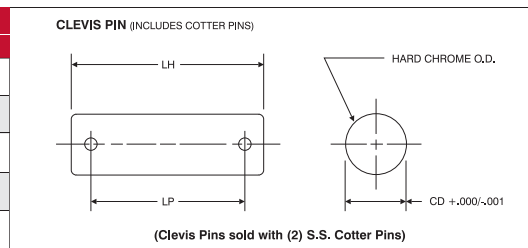

ROD CLEVIS							
Part No.	CB	CD	CE	CW	ER	KK	L
SS-RC437	¾	½	1½	½	½	7/16-20	¾
SS-RC500	¾	½	1½	½	½	½-20	¾
SS-RC750	1¼	¾	2¾	5/8	¾	¾-16	1¼
SS-RC1000	1½	1	3½	¼	1	1-14	1½
SS-RC1250	2	1¾	4½	1	1¾	1¼-12	2½
SS-RC1500	2½	1¾	4½	1¼	1¾	1½-12	2¼

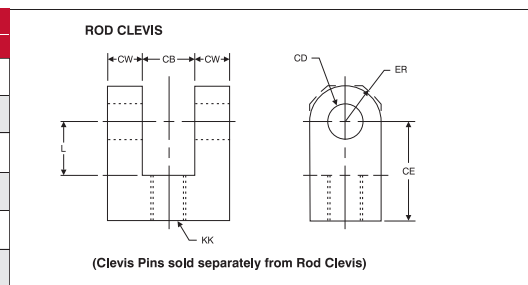

ROD EYE						
Part No.	A	CA	CB	CD	ER	KK
SS-RE437	¾	1½	¾	½	5/8	7/16-20
SS-RE500	¾	1½	¾	½	5/8	½-20
SS-RE750	1½	2 <sup>1</sup> / <sub>16</sub>	1¼	¾	7/8	¾-16
SS-RE1000	1½	2 <sup>13</sup> / <sub>16</sub>	1½	1	1 <sup>3</sup> / <sub>16</sub>	1-14
SS-RE1250	2	3 <sup>7</sup> / <sub>16</sub>	2	1¾	1 <sup>9</sup> / <sub>16</sub>	1¼-12
SS-RE1500	2¼	4	2½	1¾	2	1½-12

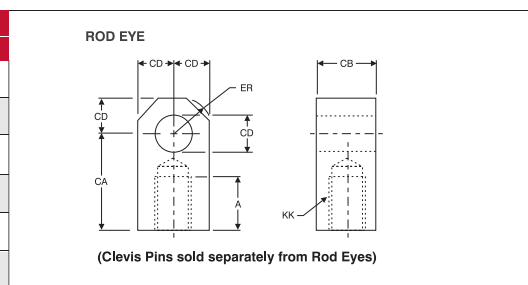

CLEVIS BRACKETS AND EYE BRACKETS											
	Part No.	BA	CB	CD	CW	DD	E	F	FL	L	M
CLEVIS BRACKETS	SS-CB500	1 <sup>5</sup> / <sub>8</sub>	¾	½	½	3/8-24	2½	3/8	1½	¾	5/8
	SS-CB750	2 <sup>9</sup> / <sub>16</sub>	1¼	¾	5/8	½-20	3½	5/8	1 <sup>7</sup> / <sub>8</sub>	1¼	¾
	SS-CB1000	3¼	1½	1	¾	5/8-18	4½	¾	2¼	1½	1
EYE BRACKETS	SS-EB500	1 <sup>5</sup> / <sub>8</sub>	¾	½		13/32	2½	3/8	1½	¾	½
	SS-EB750	2 <sup>9</sup> / <sub>16</sub>	1¼	¾	N/A	17/32	3½	5/8	1 <sup>7</sup> / <sub>8</sub>	1¼	¾
	SS-EB1000	3¼	1½	1		21/32	4½	¾	2¼	1½	1

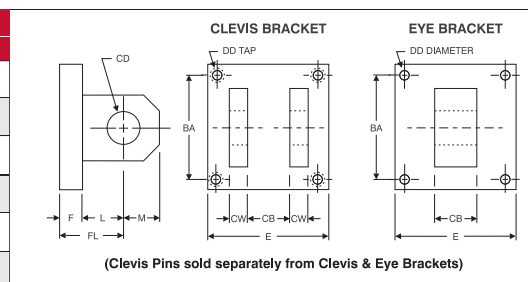

# MN Accessories: R10, R10P, RAC, MSS Switches

Milwaukee Cylinder offers Reed, High Power AC Reed, DC Solid State and Reed Switches with built-in circuit protection to meet a wide variety of customer needs.

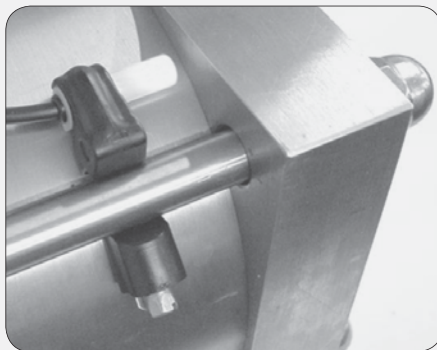

## SWITCHES

- Miniature AC/DC Reed
- High Power AC Reed
- CE RoHS
- Miniature AC/DC Reed with built-in Circuit Protection
- Extended Temperature Range Reed
- Miniature DC Solid State

### Advantages:

- Compact low profile switch/bracket assembly
- Switches and brackets are nylon and stainless steel hardware construction – suitable for wash down or corrosive environments (IP67)
- Quick, simple set-up: Requires standard (slotted) screw driver only
- High visibility LED can be seen up to 20 feet
- Optional quick connect threaded coupling on low current model
- Magnetically operated, can be located anywhere in the actuator stroke range
- Can be used with the MN Series Milwaukee Cylinder aluminum actuators, electroless nickel plated series, and stainless steel

(Note: Specify “MPR” option when ordering actuator)

- Suitable for all bore sizes (1½" to 12")
- One magnet (MPR) for all switch models

### Benefits of REED Switch:

- Internal circuit protection
- Lower cost
- Low or high current models available, AC or DC, and TRIAC type switch for inductive loads
- High visibility red LED (on low current models)
- Choice of lead lengths available on all models
- Optional quick connect threaded coupling on low current model

### Benefits of SOLID STATE Switch:

- Faster signal speeds
- Solid State Reliability – No moving parts means long life, no contact bounce or wear
- Reverse Polarity and Over Voltage Protection
- High Visibility Red LED (all models)
- Choice of lead lengths available or Quick Connect Threaded Coupling

### R10 Miniature REED Switch

- 5-120 Volts AC, 5-110 Volts DC, 400 mA current rating (max.)
- Cable options include 24" or 120" plain cable leads, and 8mm threaded quick connect
- High visibility LED

### R10P Miniature AC/DC REED Switch with built-in Circuit Protection

- 5-120 Volts AC, 5-110 Volts DC, 150 mA current rating (max.)
- Cable options include 24" or 120" plain cable leads
- High visibility LED
- Circuit protection consisting of varistor/choke arrangement that will protect switch from transients, voltage spikes and inrush currents usually associated with long cable runs (particularly at higher voltages) and unprotected inductive loads such as relays, solenoids, motors, and motor starters and some PLC's

### MSS Miniature SOLID STATE Switch

- 10-30 Volts DC, 4-300 mA current rating
- Can be wired current sinking (NPN) or current sourcing (PNP)
- Cable options include 24" or 120" plain cable leads, and 8mm threaded quick connect
- High visibility LED

### RAC High Power AC REED Switch

- 12-240 Volts AC, 800 mA current rating, TRIAC output
- Cable options include 24" or 120" plain cable leads

## ▼ SWITCH APPLICATION SELECTION GUIDE For selecting the right switch for your application

Switch Model	Programmable Controllers	Relays	Solenoids	Indicator Lights		Motors	Time Counters
				Bulbs	Solid State		
R10 Reed	Yes	<10VA*	<10VA*	<10VA*	Yes	<10VA*	<10VA*
RAC High Powered Reed**	No	Yes	Yes	Yes	No	Yes	Yes
R10P Reed	Yes	<10VA	<10VA	<10VA	No	<10VA	<10VA
MSS Solid State	Yes	<300mA	No	<300mA	Yes	No	<300mA

\*Use resistor-capacitor protection

\*\*Minimum current = 80mA

Series H

## R10 / R10X

### MINIATURE REED SWITCH, CABLE TYPE, (Two Wire Switch)

**R10:** Miniature Reed Switch, 24" Plain Cable Lead, (2 wire Switch)  
**R10X:** Miniature Reed Switch, 120" Plain Cable Lead, (2 wire Switch)  
**Contacts:** SPST Form A (Normally Open)  
**Contact Rating:** 10 Watts Max.  
**Input Voltage:** 5-120 Volts Max. AC, 5-110 Volts Max. DC  
**Maximum Load Current:** 400 mA Max. (Resistive) @ 25° C (77° F)  
 150 mA Max. (Resistive) @ 70° C (158° F)  
**Actuating Time Average:** 1.0 millisecond  
**LED Indicator:** High Luminescence Housing  
**Temperature Range:** -20° C to 70° C (-4° F to 158° F)  
**Protection Rating:** IP67

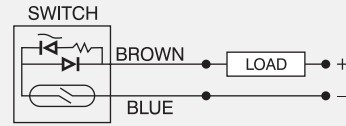

**Input Voltage:** 110 Volts Max. DC, 120 Volts Max. AC  
**Maximum Load Current:** 400 mA Max. (Resistive) @ 25° C (77° F)  
 150 mA Max. (Resistive) @ 70° C (158° F)

Series MH

## R10Q

### MINIATURE REED SWITCH, 8mm MALE QUICK CONNECT, (Two Wire Switch)

**R10Q:** Miniature Reed Switch, 8mm Male Quick Connect, (2 wire Switch)  
**Contacts:** SPST Form A (Normally Open)  
**Contact Rating:** 10 Watts Max.  
**Input Voltage:** 60 Volts Max. AC or DC  
**Maximum Load Current:** 400 mA Max. (Resistive) @ 25° C (77° F)  
 150 mA Max. (Resistive) @ 70° C (158° F)  
**Actuating Time Average:** 1.0 millisecond  
**LED Indicator:** High Luminescence Housing  
**Temperature Range:** -20° C to 70° C (-4° F to 158° F)  
**Protection Rating:** IP67

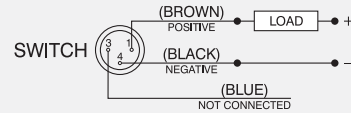

**Input Voltage:** 60 Volts Max. AC or DC  
**Maximum Load Current:** 400 mA Max. (Resistive) @ 25° C (77° F)  
 150 mA Max. (Resistive) @ 70° C (158° F)

Series LH

Series A

## R10P/R10PX

### MINIATURE REED SWITCH, 24" PLAIN CABLE LEAD, CIRCUIT PROTECTION, (Two Wire Switch)

**R10P:** Miniature Reed Switch, 24" Plain Cable Lead, Circuit Protection (2 wire Switch)  
**R10PX:** Miniature Reed Switch, 120" Plain Cable Lead, Circuit Protection (2 wire Switch)  
**Contacts:** SPST Form A (Normally Open)  
**Contact Rating:** 10 Watts Max.  
**Input Voltage:** 5-120 Volts Max. AC, 110 Volts Max. DC  
**Maximum Load Current:** 150 mA Max. (Resistive)  
**Actuating Time Average:** 1.0 millisecond  
**LED Indicator:** High Luminescence Housing  
**Temperature Range:** -20° C to 70° C (-4° F to 158° F)  
**Protection Rating:** IP67

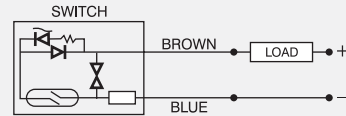

**Input Voltage:** 120 Volts Max. AC, 110 Volts Max. DC  
**Maximum Load Current:** 150 mA Max.

#### Circuit Protection

**Varistor:** 138 Volts  
**Choke:** 680 μH

**Note:** The circuit protection consists of a Varistor and Choke arrangement. The Varistor will take transient and voltage spikes out of the line and is mounted in parallel with the switch. The Choke will disperse inrush currents (normally caused by long cable runs) and is mounted in series with the switch.

Series MN

## RAC / RACX

### HIGH POWER AC REED SWITCH, CABLE TYPE, (Two Wire Switch)

**RAC:** High Power AC Reed Switch, 24" Plain Cable Lead, (2 wire Switch)  
**RACX:** High Power AC Reed Switch, 120" Plain Cable Lead, (2 wire Switch)  
**Contacts:** TRIAC Output  
**Contact Rating:** 200 Watts Max.  
**Input Voltage:** 12 to 240 Volts (AC only)  
**Minimum Load Current:** 80 mA  
**Maximum Load Current:** 800 mA  
**Actuating Time Average:** 2.0 milliseconds  
**LED Indicator:** Not Available  
**Temperature Range:** -20° C to 70° C (-4° F to 158° F)  
**Protection Rating:** IP67

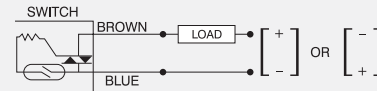

**Contact Rating:** 200 Watts Max.  
**Input Voltage:** 12 to 240 Volts (AC only)  
**Minimum Load Current:** 80 mA  
**Maximum Load Current:** 800 mA

### LOAD CURRENT DE-RATING GRAPH

**R10 / R10X / R10Q**  
**(R10PX: 150 mA MAX., -20°C to 70°C)**

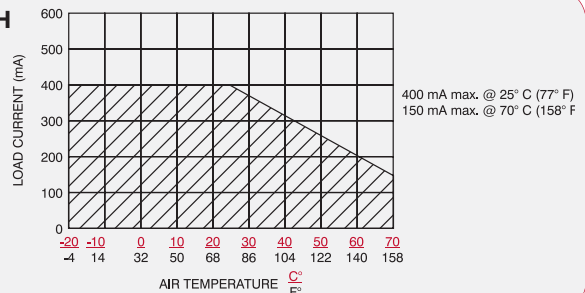

## MSS / MSSX

### MINIATURE SOLID STATE SWITCH, CABLE TYPE, (Two Wire Switch)

<b>MSS:</b>	Miniature Solid State Switch, 24" Plain Cable Lead, (2 wire Switch)
<b>MSSX:</b>	Miniature Solid State Switch, 120" Plain Cable Lead, (2 wire Switch)
*Output Type:	Current Sinking or Current Sourcing
Input Voltage:	10 to 30 Volts DC
Current Consumption (not sensing):	1mA
Minimum Load Current:	4 mA
Maximum Load Current:	300 mA
“ON” Voltage Drop:	3 Volts @ 4 mA 4 Volts @ 300 mA
LED Indicator:	High Luminescence Housing
Temperature Range:	-20° C to 70° C (-4° F to 158° F)
Actuating Time Average:	2.0 Microseconds
Protection Rating:	IP67
Reverse Polarity Protected:	Yes
Transient (over voltage) Protected:	Yes

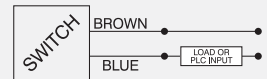

Typical Current Sourcing (PNP) Configuration



Typical Current Sinking (NPN) Configuration

**\*NOTE:** This is a (2) wire switch used in series with the load. Therefore, this switch can be used with devices requiring either a current sinking (NPN) output or a current sourcing (PNP) output from the solid state switch.

## MSSQ

### MINIATURE SOLID STATE SWITCH, 8mm MALE QUICK CONNECT, (Two Wire Switch)

<b>MSSQ:</b>	Miniature Solid State Switch, 8mm Male Quick Connect (2 wire Switch)
*Output Type:	Current Sinking or Current Sourcing
Input Voltage:	10 to 30 Volts DC
Current Consumption (not sensing):	1mA
Minimum Load Current:	4 mA
Maximum Load Current:	300 mA
“ON” Voltage Drop:	3 Volts @ 4 mA 4 Volts @ 300 mA
LED Indicator:	High Luminescence Housing
Temperature Range:	-20° C to 70° C (-4° F to 158° F)
Actuating Time Average:	2.0 Microseconds
Protection Rating:	IP67
Reverse Polarity Protected:	Yes
Transient (over voltage) Protected:	Yes



Typical Current Sourcing (PNP) Configuration

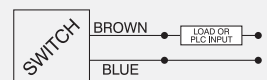

Typical Current Sinking (NPN) Configuration

**\*NOTE:** This is a (2) wire switch used in series with the load. Therefore, this switch can be used with devices requiring either a current sinking (NPN) output or a current sourcing (PNP) output from the solid state switch.

Series H

Series MH

Series LH

Series A

Series MN

## SWITCHES

### R10 / R10X MSS / MSSX

**PLAIN CABLE LEADS**  
R10 / MSS = 24" (0.6m) JACKETED LEADS  
R10X / MSSX = 120" (3.0m)  
(JACKET CUT BACK 1" ON END) (25.4)

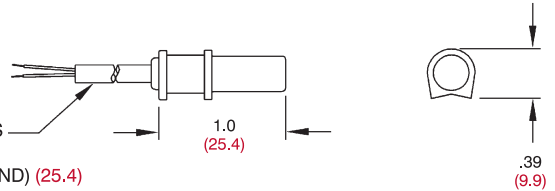

### R10Q MSSQ

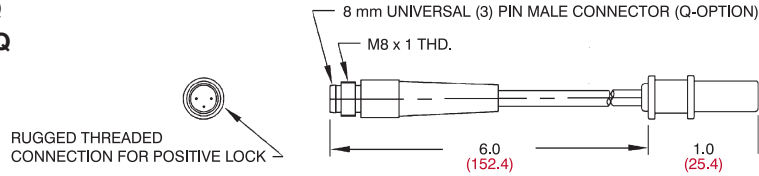

### RAC / RACX R10P / R10PX

**PLAIN CABLE LEADS**  
R10P / RAC = 24" (0.6m) JACKETED LEADS  
R10PX / RACX = 120" (3.0m)  
(JACKET CUT BACK 1" ON END) (25.4)

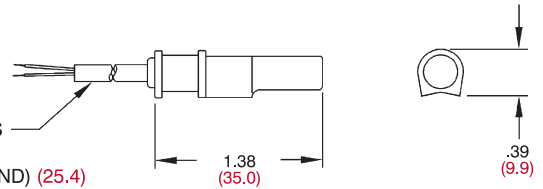

## SWITCH BRACKETS

### SB15 (For 1½" Through 2½" Bore Cylinders)

**Bracket Construction:**  
Molded Nylon 6 (Black) and  
Stainless Steel Hardware

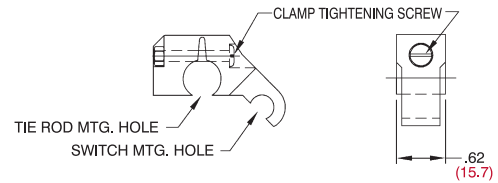

### SB32 (For 3¼" Through 12" Bore Cylinders)

**Bracket Construction:**  
Molded Nylon 6 (Black) and  
Stainless Steel Hardware

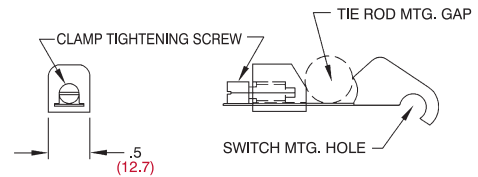

## QUICK CONNECT CORD SET

(Used with "Q" Type Switch Leads)

**FOR CABLES:**  
C4-T (2 METER CABLE LENGTH)  
C4X-T (5 METER CABLE LENGTH)

**CONDUCTOR COLORS:**  
1. BROWN  
3. BLUE  
4. BLACK

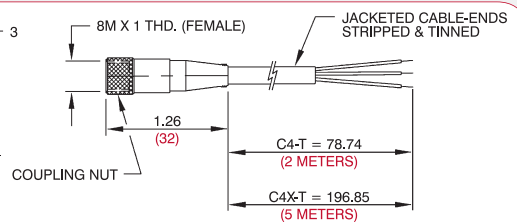

All dimensions are in inches (metric in parentheses)

# MN Accessories: Switch Mounting

## SB15 / SB32

### SB15

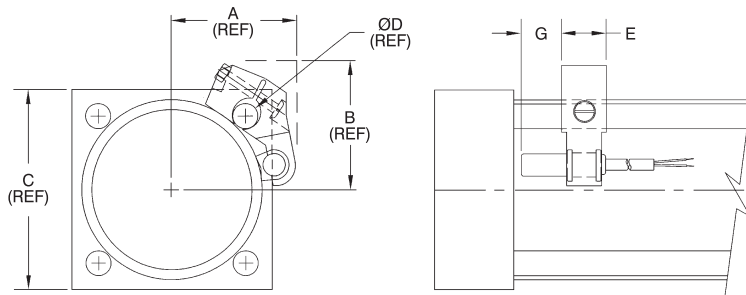

### SB32

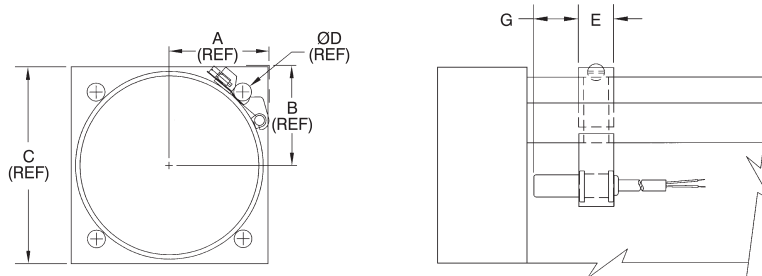

### ▼ SWITCH BORE DIMENSIONAL TABLE

Part #	Bore Ø	A	B	C	D	E	G
SB15	1½	1¾	1 <sup>13</sup> / <sub>32</sub>	2	¼	5⁄8	½
	2	1 <sup>5</sup> / <sub>8</sub>	1 <sup>21</sup> / <sub>32</sub>	2½	5⁄16	5⁄8	½
	2½	1 <sup>7</sup> / <sub>8</sub>	1 <sup>7</sup> / <sub>8</sub>	3	5⁄16	5⁄8	½
SB32	3¼	2 <sup>1</sup> / <sub>8</sub>	2 <sup>1</sup> / <sub>8</sub>	3¾	3⁄8	½	9⁄16
	4	2 <sup>7</sup> / <sub>16</sub>	2 <sup>3</sup> / <sub>8</sub>	4½	3⁄8	½	9⁄16
	5	2 <sup>7</sup> / <sub>8</sub>	2 <sup>3</sup> / <sub>4</sub> *	5½	½	½	9⁄16
	6	3¼*	3¼*	6½	½	½	9⁄16
	8	4¼*	4¼*	8½	5⁄8	½	9⁄16
	10	5 <sup>5</sup> / <sub>16</sub> *	5 <sup>5</sup> / <sub>16</sub> *	10 <sup>5</sup> / <sub>8</sub>	¾	½	9⁄16
12	6 <sup>3</sup> / <sub>8</sub> *	6 <sup>3</sup> / <sub>8</sub> *	12¾	¾	½	9⁄16	

\* These dimensions are 1/2 of the 'C' dimension. The switch bracket **does not** protrude beyond standard head/cap.

### ▼ HOW TO ASSEMBLE SWITCH AND BRACKETS

**Recommended Torque:**  
6-10 in-lbs.  
(Do not exceed 14 in-lbs)

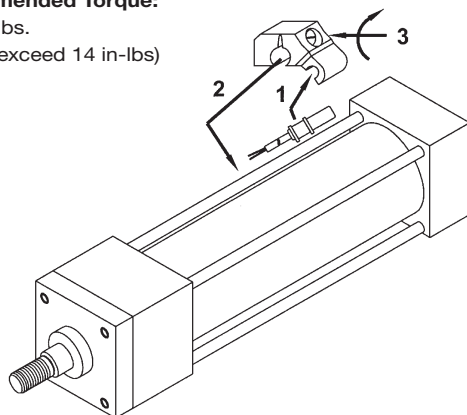

**SB15 SWITCH BRACKET  
(MOUNTING ILLUSTRATION)**

**Recommended Torque:**  
8-12 in-lbs.  
(Do not exceed 14 in-lbs)

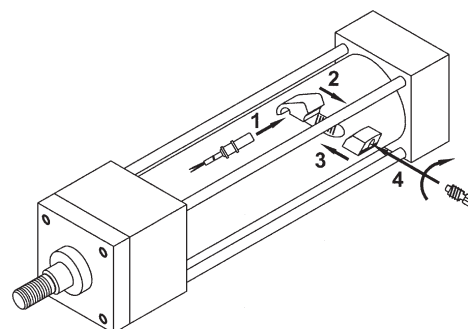

**SB32 SWITCH BRACKET  
(MOUNTING ILLUSTRATION)**

Series H

Series MH

Series LH

Series A

Series MN

### HYSTERESIS:

The distance between the switch break point moving in one direction, and the switch make point moving in the opposite direction.

### BAND WIDTH:

Distance the piston moves while the switch is made (in either direction), less the hysteresis.

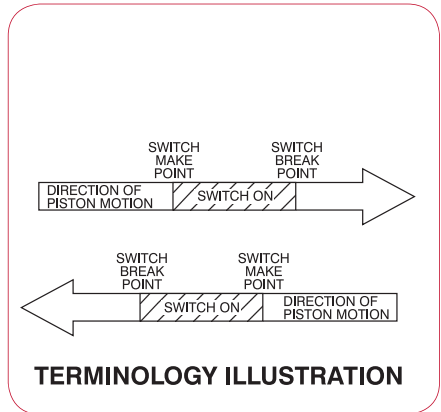
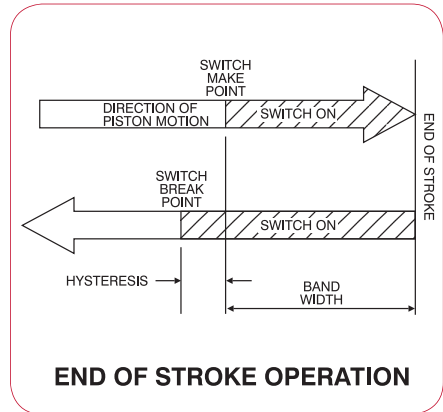
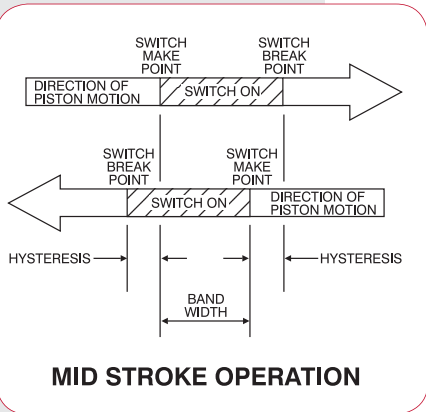

### R10 / R10X / R10Q

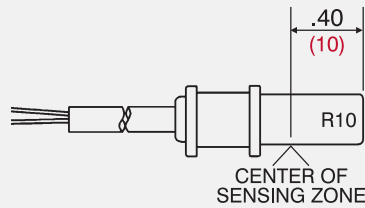

Repeatability	Hysteresis (Maximum)	Band Width (Minimum)
±.010" (±0,25 mm)	.040" (1 mm)	.200" (5 mm)

### R10P / R10PX

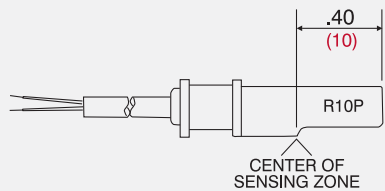

Repeatability	Hysteresis (Maximum)	Band Width (Minimum)
±.010" (±0,25 mm)	.040" (1 mm)	.200" (5 mm)

### RAC / RACX

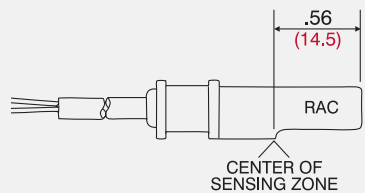

Repeatability	Hysteresis (Maximum)	Band Width (Minimum)
±.010" (±0,25 mm)	.085" (2,1 mm)	.345" (8,8 mm)

### MSS / MSSX / MSSQ

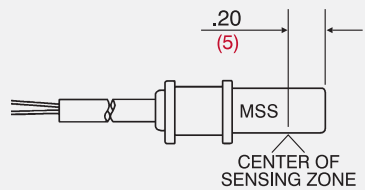

Repeatability	Hysteresis (Maximum)	Band Width (Minimum)
±.010" (±0,25 mm)	.075" (1,9 mm)	.315" (8 mm)

**NOTE:** Dimensions are in inches, (metric in parentheses). Results are based upon Milwaukee Cylinder's piston and magnet assemblies. Results may vary if used with other manufacturers cylinder products.

# MN Accessories: Switch Ordering Instructions

## ▼ CONFIGURE YOUR SWITCH PART NUMBER

### TO ORDER, SPECIFY:

Switch Model, Lead Type,  
and Bracket Size



Switch Model	
R10	= AC/DC Reed
RAC	= High Power AC Reed
MSS	= Solid State
R10P	= AC/DC Reed with Circuit Protection

Switch Lead Type	
(leave blank)	= 24" Plain Cable
X	= 120" Plain Cable
Q	= 8mm Quick Connect (not available on RAC or R10P)

Switch Bracket Size	
SB15	= 1½" to 2½" Bore
SB32	= 3¼" to 12" Bore
(leave blank)	for switch only

## ▼ SWITCH ACCESSORIES

Quick Connect Cord Sets	
Model	Description
C4-T	8mm Straight Quick Connect Cord X 2 Meter (78")
C4X-T	8mm Straight Quick Connect Cord X 5 Meter (196")

## ABOUT OUR SWITCHES

Our switches are different! The most common complaint in the market is the unreliability of magnetically operated switches. Most cylinder piston magnets have about 10-30% more power than required to operate the switch. This results in erratic operation, a nuisance for maintenance and lowering overall plant productivity.

*Milwaukee Cylinder's* magnets have 50-100% more power than required to operate our switch! The combination of *Milwaukee Cylinder's* R10, R10P, RAC and MSS Switches and our Cylinders, raises the reliability of switch operation comparable to that of many mechanically operated limit switches.

## APPLICATION RECOMMENDATIONS AND PRECAUTIONS

- Noise suppression — Motors and valve solenoids will produce high pulses throughout an electrical system. Therefore, primary and control circuit wiring should not be mixed in the same conduit. Separate power supplies for both logic level signals (Microprocessor, P.C., CPU, Input Devices) and Output Field Devices (Motors, Valve Solenoids) is recommended.
- Never connect R10, R10P or MSS type switches without a load present. The switch will be destroyed.
- Some electrical loads may be capacitive. Capacitive loading may occur due to distributed capacity in cable runs over 25 feet. Use switch model RAC whenever capacitive loading may occur.
- To obtain optimum performance and long life, switches should not be subjected to strong magnetic fields, extreme temperatures (outside of specifications), or excessive ferrous filings or chip buildup.
- Improper wiring may damage or destroy the switch. Therefore, the wiring diagrams along with the listed power ratings, should be carefully observed before connecting power to the switch.

*Following these tips can save time and provide trouble free installations!*

**Other switches available:**

- 12mm Quick Connect
- Pulse Extension Switch
- Special Length Cable
- Change Over Switch (SPDT)
- Weld Immune Switch
- High Temp. Switch

*(Consult factory for details.)*



## ▼ CONFIGURE YOUR CYLINDER (Series MN cylinder)

1 2 3 4 5 6 7 X 14<sup>3</sup>/<sub>4</sub>

**1** Double Rod End add "D"  
**2** Cylinder Code  
**3** NFPA Mounts  
**4** Cushions  
**5** Options  
**6** Seals  
**7** Stroke

### Part Number System

Example: A 3<sup>1</sup>/<sub>4</sub>" Bore, 1" rod, MF1 mount, cushion both ends, Style KK2 rod end, standard seals with a 14<sup>3</sup>/<sub>4</sub>" stroke.

**Part Number:**  
MN06130-31-HC-KK2-7 x 14<sup>3</sup>/<sub>4</sub>

2 CYLINDER CODE		
Bore Ø	Rod Ø	Cylinder Code
1½	5/8	MN00611
	1	MN00612
2	5/8	MN06110
	1	MN06111
2½	5/8	MN06120
	1	MN06121
3¼	1	MN06130
	1 1/8	MN06131
4	1	MN06140
	1 1/8	MN06141
5	1	MN06150
	1 1/8	MN06151
6	1 1/8	MN06160
	1 1/4	MN06161
8	1 1/8	MN06180
	1 1/4	MN06181
10	1 1/4	MN61100
	2	MN61101
12	2	MN61200
	2 1/2	MN61201

3 NFPA MOUNTS		
	Description	
31	MF1	Front Flange (1½"-6" Bore)
32	MF2	Rear Flange (1½"-6" Bore)
21	ME3	Front Mounting Holes (8"-12" Bore)
22	ME4	Rear Mounting Holes (8"-12" Bore)
61	MP1	Rear Pivot Clevis (1½"-12" Bore)
63	MP2	Rear Pivot Clevis, Removable (1½"-6" Bore)
64	MP4	Rear Fixed Eye Mount, Removable (1½"-6" Bore)
44	MS1	Front & Rear End Angle (1½"-8" Bore)
42	MS2	Side Lug (1½"-8" Bore)
41	MS4	Bottom Tapped Holes (1½"-12" Bore)
71	MT1	Front Trunnion (1½"-8" Bore)
72	MT2	Rear Trunnion (1½"-8" Bore)
74	MT4	Intermediate Trunnion (1½"-8" Bore)
11	MX0	No Mount (1½"-12" Bore)
10	MX1	Extended Tie Rods - Head & Cap (1½"-12" Bore)
13	MX2	Extended Tie Rods (Cap) (1½"-12" Bore)
12	MX3	Extended Tie Rods (Head) (1½"-12" Bore)

4 CUSHIONS	
	Description
H	Head Cushion Position 2 is Standard Specify for Positions: 1, 3 & 4
LH	Long Head Cushion Position 2 is Standard Specify For Positions: 1, 3 & 4
ELH	* Extra Long Head Cushion Position 2 is Standard Specify for Positions: 1, 3 & 4
C	Cap Cushion Position 2 is Standard Specify for Positions: 1, 3 & 4
LC	Long Cap Cushion Position 2 is Standard Specify for Positions: 1, 3 & 4
ELC	* Extra Long Cap Cushion Position 2 is Standard Specify for Positions: 1, 3 & 4
NC	No Cushion

6 SEALS	
7	BUNA (-30° to 250° F)
8	VITON (-15° to 350° F)
S	SPECIAL

7 STROKE	
0" to 120" / Made to order.	

5 OPTIONS	
Add length to cylinder - See "Option Length Adder" Chart Below	
<b>KK1</b>	Standard
<b>A</b>	Extended piston rod thread (Example: A = 2")
<b>AS</b>	Adjustable stroke - retract (specify length, example: AS = 4")
<b>A/O</b>	Air / oil piston
<b>*B</b>	¼" Urethane bumper both ends
<b>*BC</b>	¼" Urethane bumper cap only
<b>*BH</b>	¼" Urethane bumper head only
<b>BP</b>	Bumper piston seals (1½" - 8" bore)
<b>BSPP</b>	BSPP ports (specify size, example: BSPP = ¼")
<b>BSPT</b>	BSPT ports (specify size, example: BSPT = ¼")
<b>C</b>	Extended piston rod (example: C = 3")
<b>EN</b>	Electroless nickel plated (see page 118 for specifications)
<b>KK2</b>	Large male rod thread
<b>KK3</b>	Female rod thread
<b>KK3S</b>	Studded piston rod (KK3 with stud, loctite in place)
<b>KK4</b>	Full diameter male rod thread
<b>KK5</b>	Blank rod end (no threads, "A" = 0")
<b>LF</b>	Low friction seals (see page 118 for specifications)
<b>MA</b>	Micro-adjust (6" max. stroke) available on double rod end models
<b>MAB</b>	Micro-adjust with sound dampening bumper (6" max. stroke)
<b>MPR</b>	Magnetic piston for Reed or Solid State switches R10, RAC, and MSS (see pages 127-133 for selection)
<b>MPH</b>	Magnetic piston for hall switches
<b>MS</b>	Metallic rod scraper (brass construction)
<b>NR</b>	Non-rotating (see page 120 for specifications)
<b>OP</b>	Optional port location (example: ports at 2 and 3)
<b>OS</b>	Oversize rod diameter (specify size, example: OS = 1 1/8")
<b>SAE</b>	Sae ports (specify size, example: SAE #10)
<b>SE</b>	Spring extend (1½, 2, 2½ inch bore)
<b>SR</b>	Spring return (1½, 2, 2½ inch bore)
<b>SSA</b>	Stainless steel piston rod, tie rods & nuts, and fasteners
<b>SSF</b>	Stainless steel fasteners
<b>SSR</b>	Stainless steel piston rod
<b>SST</b>	Stainless steel tie rods & nuts
<b>*ST</b>	Stop tube (specify stop tube length and effective stroke) (example: MN MS4 2 x 24" effective stroke-ST=3)
<b>Steel tube</b>	Steel cylinder tube, black epoxy paint finish
<b>TH</b>	400 psi hydraulic non-shock (see page 123 for specifications)
<b>XX</b>	Special variation (specify)

\* Add length to cylinder - See "Options Length Adder" chart below

OPTIONS LENGTH ADDER						
(add to catalog basic overall length dimensions.)						
Bore Ø	OPTION					ST* (Stop Tube) Example: ST=2
	B	BC	BH	ELC	ELH	
1½	1/2	1/4	1/4	1	1	2
2	1/2	1/4	1/4	1	1	2
2½	1/2	1/4	1/4	1	1	2
3¼	1/2	1/4	1/4	1 1/4	1 1/4	2
4	1/2	1/4	1/4	1 1/4	1 1/4	2
5	1/2	1/4	1/4	1 1/4	1 1/4	2
6	1/2	1/4	1/4	1 1/2	1 1/2	2
8	1/2	1/4	1/4	1 1/2	1 1/2	2
10	1/2	1/4	1/4	2	2	2
12	1/2	1/4	1/4	2	2	2

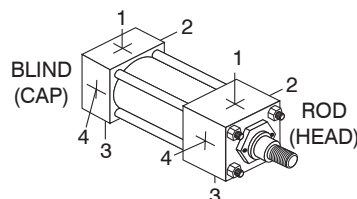

### Standard Port and Cushion Adjustment Positions

- Ports - Position 1
- Cushion adjustment - Position 2
- Specify non-standard positions when ordering